

Audi A6

Fitting Locations

No. 802 / 1

Edition 08.2008

Fuses

Overview of fuses

1 - Fuses in electronics box, right in plenum chamber

- Position of fuses, fuse holder, from model year 2005 → [page 802/62](#)
- Position of fuses, fuse holder left-hand drive, from model year 2007 → [page 802/63](#)
- Position of fuses, fuse holder right-hand drive, from model year 2007 → [page 802/64](#)

2 - Fuses on fuse holder, front passenger side

- Location of fuses (SC) on fuse holder → [page 802/35](#)
- Location of fuses (SB) on fuse holder, right-hand drive → [page 802/28](#)
- Position of fuses (SC) on fuse holder, from model year 2005 → [page 802/36](#)
- Position of fuses (SC) on fuse holder, left-hand drive, from model year 2007 → [page 802/39](#)
- Position of fuses (SC) on fuse holder, left-hand drive, from model year 2009 → [page → 802/42](#)
- Position of fuses (SB) on fuse holder, right-hand drive, from model year 2007 → [page 802/29](#)
- Position of fuses (SB) on fuse holder, right-hand drive, from model year 2009 → [page 802/32](#)

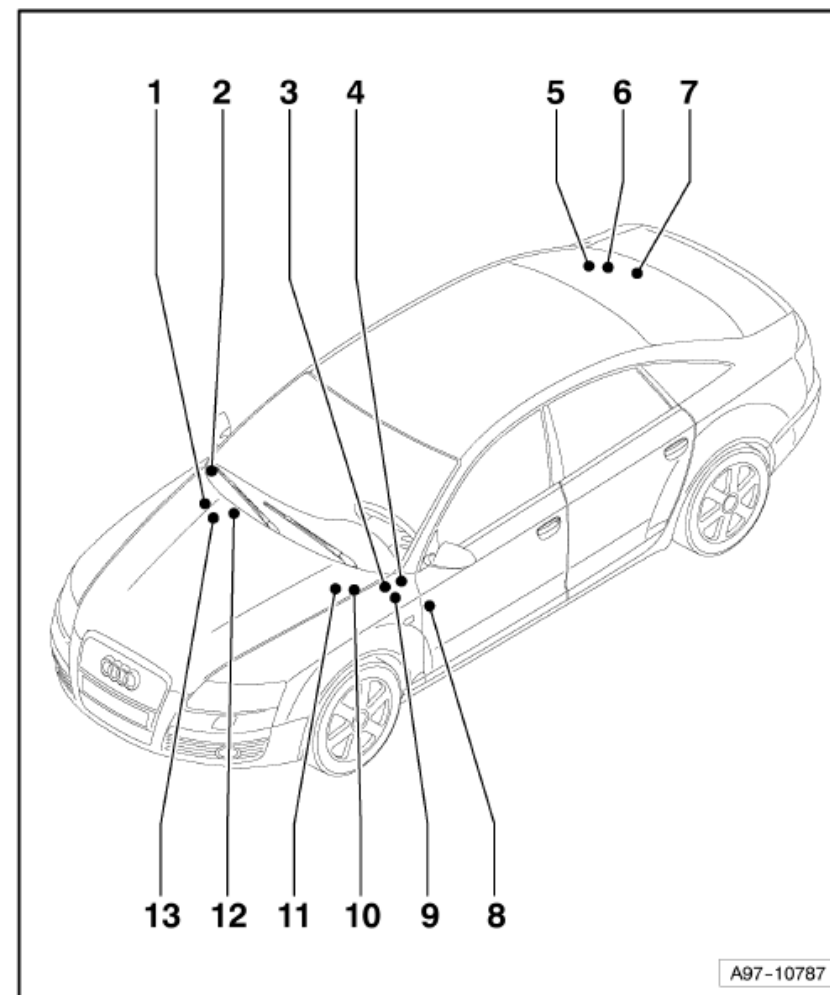

A97-10787

Audi A6

Fitting Locations

No. 802 / 2

3 - Fuses on steering cross member

- Position of fuses, fuse holder → [page 802/70](#)

4 - Fuses on onboard supply control unit -J519-

- Position of fuses, fuse holder → [page 802/61](#)

5 - Fuses (SF) on fuse holder F

- Location fuse holder → [page 802/52](#)
- Position of fuses, fuse holder, from model year 2005 → [page 802/53](#)
- Position of fuses, fuse holder, from model year 2007 → [page 802/55](#)
- Position of fuses, fuse holder, from model year 2009 → [page 802/57](#)

6 - Fuses, on right in luggage compartment

- Position of fuses, fuse holder, from model year 2005 → [page 802/67](#)
- Position of fuses, fuse holder, from model year 2007 → [page 802/69](#)

7 - Fuses in luggage compartment, rear right, on the battery

- Position of fuses, fuse holder, from model year 2007 → [page 802/72](#)

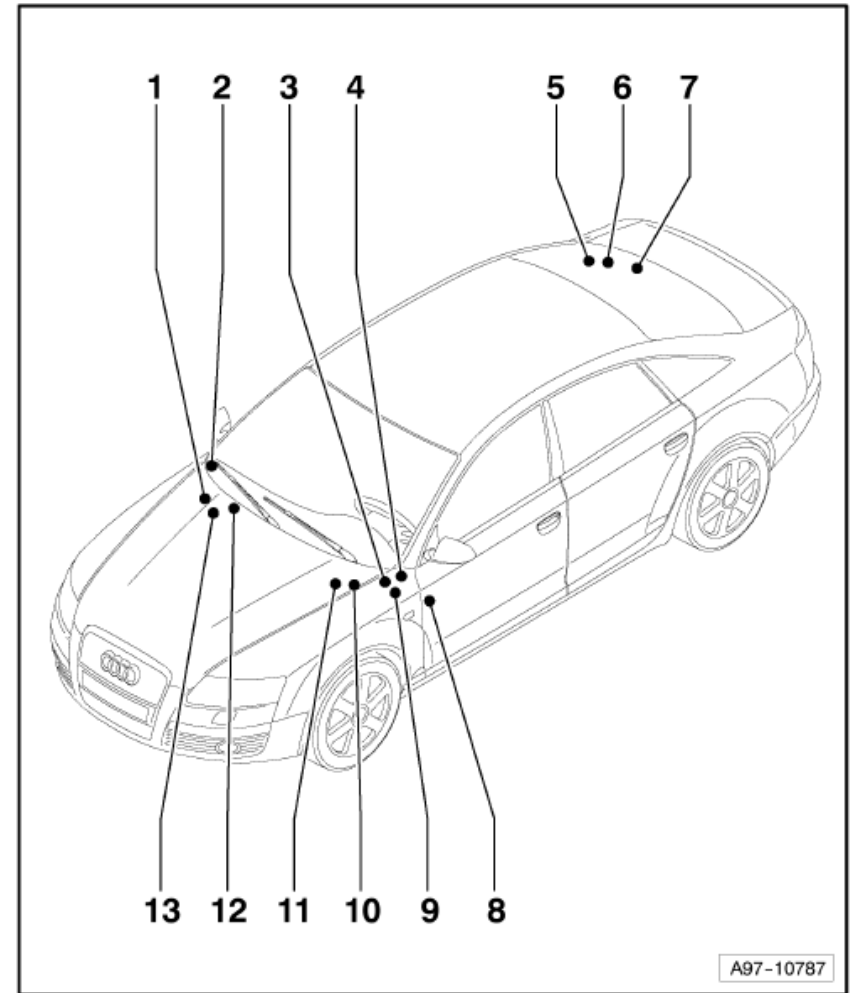

Audi A6

Fitting Locations

No. 802 / 3

8 - Fuses on fuse holder, driver side

- ❑ Location of fuses (SB) on fuse holder → [page 802/18](#)
- ❑ Location of fuses (SC) on fuse holder, right-hand drive → [page 802/45](#)
- ❑ Position of fuses (SB) on fuse holder, from model year 2005 → [page 802/19](#)
- ❑ Position of fuses (SB) on fuse holder, left-hand drive, from model year 2007 → [page 802/22](#)
- ❑ Position of fuses (SB) on fuse holder, left-hand drive, from model year 2009 → [page 802/25](#)
- ❑ Position of fuses (SC) on fuse holder, right-hand drive, from model year 2007 → [page 802/46](#)
- ❑ Position of fuses (SC) on fuse holder, right-hand drive, from model year 2009 → [page 802/49](#)

9 - Fuses behind driver's storage compartment

- ❑ Position of fuses, fuse holder, from model year 2005 → [page 802/59](#)
- ❑ Position of fuses, fuse holder left-hand drive, from model year 2007 → [page 802/60](#)
- ❑ Position of fuses, fuse holder right-hand drive, from model year 2007 → [page 802/60](#)

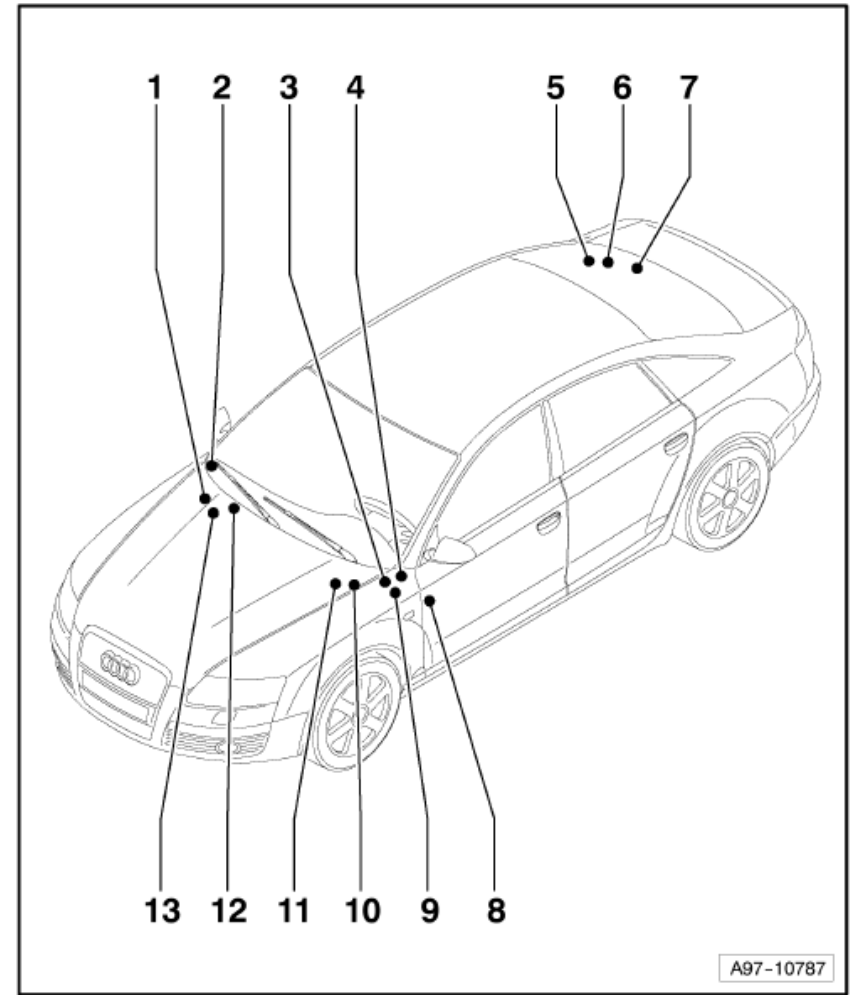

Audi A6

Fitting Locations

No. 802 / 4

10 - Fuses (SA) on fuse holder A

- ❑ Location fuse holder → [page 802/6](#)
- ❑ Location fuse holder, right-hand drive → [page 802/13](#)
- ❑ Position of fuses, fuse holder, from model year 2005 → [page 802/7](#)
- ❑ Position of fuses, fuse holder left-hand drive, from model year 2007 → [page 802/9](#)
- ❑ Position of fuses, fuse holder left-hand drive, from model year 2009 → [page 802/11](#)
- ❑ Position of fuses, fuse holder right-hand drive, from model year 2007 → [page 802/14](#)
- ❑ Position of fuses, fuse holder right-hand drive, from model year 2009 → [page 802/16](#)

11 - Fuses in electronics box, left in plenum chamber

- ❑ Position of fuses, fuse holder left-hand drive, from model year 2007 → [page 802/65](#)
- ❑ Position of fuses, fuse holder right-hand drive, from model year 2007 → [page 802/66](#)

12 - Fuses on coupling station, lower part of right A-pillar

- ❑ Position of fuses, fuse holder → [page 802/73](#)

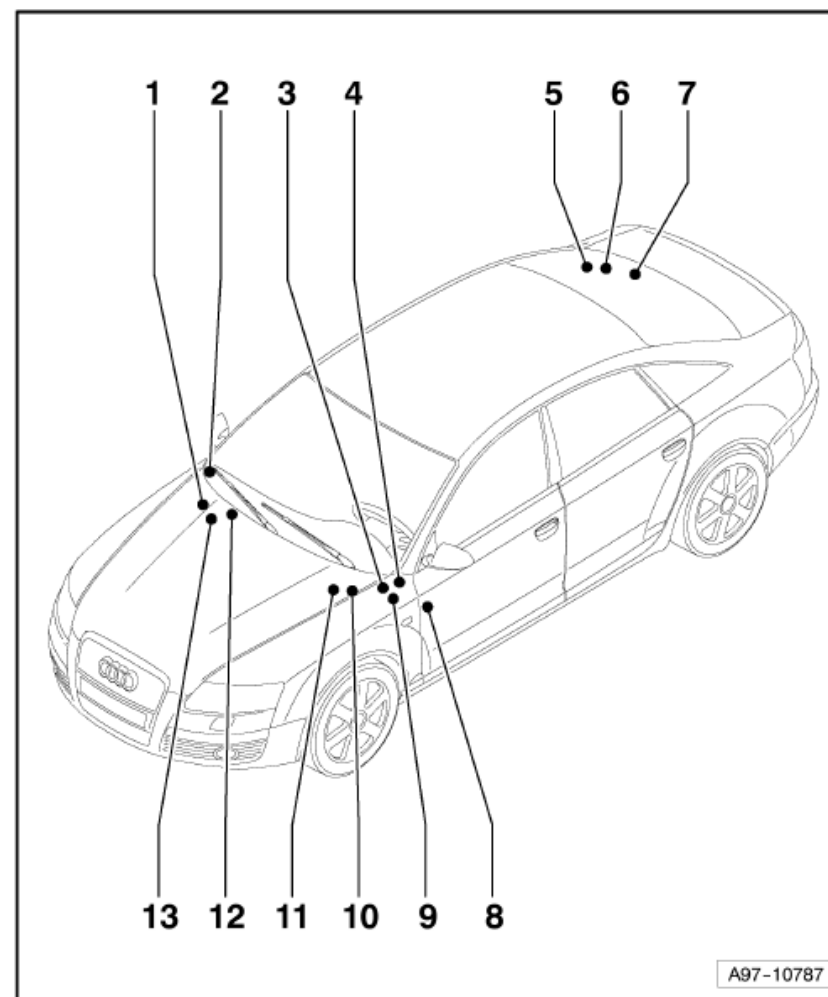

Audi A6

Fitting Locations

No. 802 / 5

13 - Fuses on main fuse carrier electronics box, right in plenum chamber

- Position of fuses, fuse holder → [page 802/71](#)

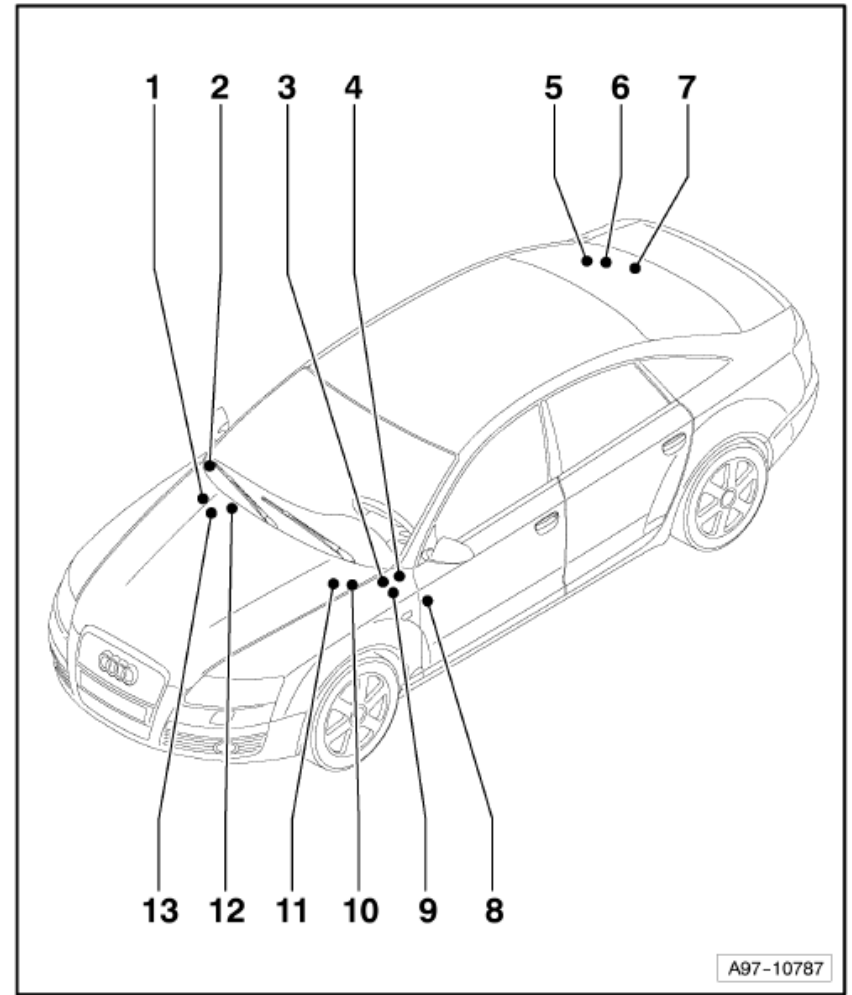

Audi A6

Fitting Locations

No. 802 / 6

Location of fuses (SA), in electronics box left in plenum chamber

Fuse colours

- 40 A - orange
- 30 A - green
- 25 A - white
- 20 A - yellow
- 15 A - blue
- 10 A - red
- 7.5 A - brown
- 5 A - beige
- 3 A - purple

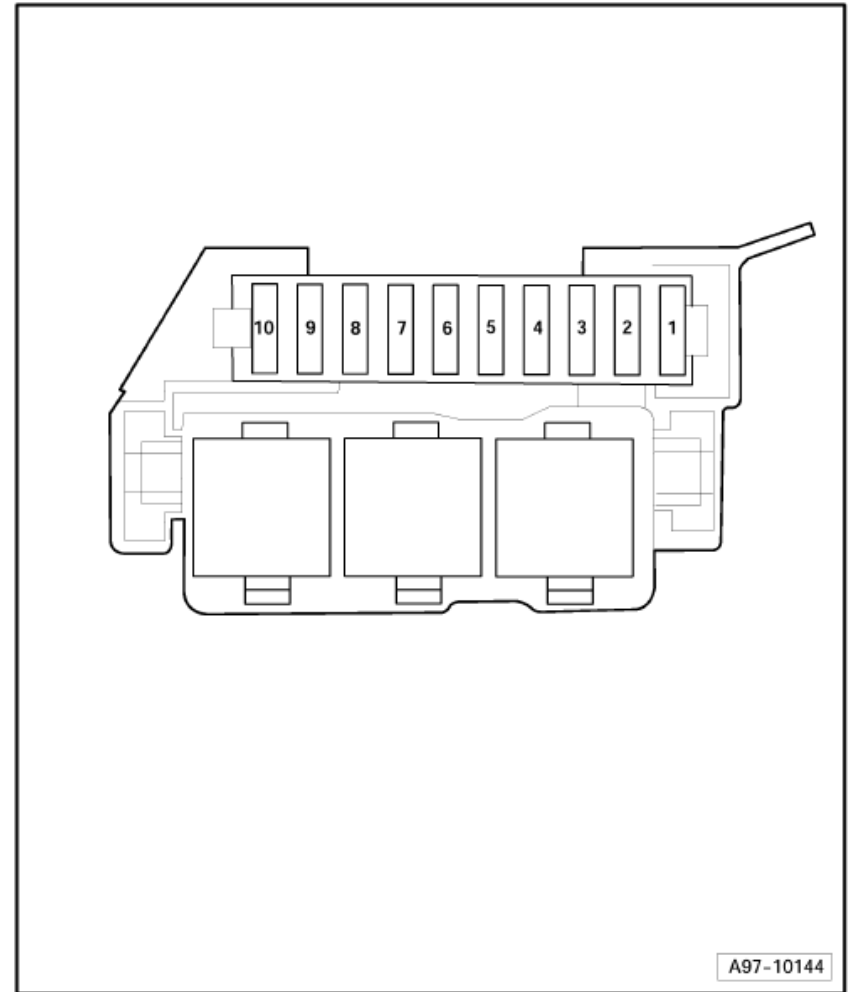

Audi A6

Fitting Locations

No. 802 / 7

Position of fuses, fuse holder, from model year 2005

No.	Current Flow Diagram designation	Nominal value	Function/component	Terminal
1	- SA11 - Fuse 1 on fuse holder in engine compartment	15A	- J569 - Brake servo relay	30
2	- SA12 - Fuse 2 on fuse holder in engine compartment	20A 30A 15A	N... - Ignition coils (BBJ, BDW, AUK) N... - Ignition coils (BAT, BGS) N184 Clutch actuator breather valve - Automatic glow period control unit J179 - High heat output relay J360 - Turbocharger 1 control unit J724 - Left electrohydraulic engine mounting solenoid valve N144 Right electrohydraulic engine mounting solenoid valve - Intake manifold flap motor N145 Intake manifold flap 2 motor - V157 - V275 -	87
3	- SA13 - Fuse 3 on fuse holder in engine compartment	10A 15A	J151 - Continued coolant circulation relay (BBJ, BDW, BAT) J496 - Additional coolant pump relay (AUK, BGS) N276 Fuel pressure regulating valve (BMK) - Fuel metering valve (BMK) N290 Inlet camshaft control valve 1 (AUK, BBJ, BDW, BAT, BGS) - Inlet camshaft control valve 2 (AUK, BBJ, BDW, BAT) N205 Exhaust camshaft control valve 1 (AUK, BBJ, BAT, BGS) - Exhaust camshaft control valve 2 (AUK, BBJ, BDW, BAT) Map-controlled engine cooling system thermostat (BGS) N208 Intake manifold flap motor (BGS) - Variable intake manifold motor (BGS) N318 - N319 - F265 - V157 -	87

Audi A6

Fitting Locations

No. 802 / 8

No.	Current Flow Diagram designation	Nominal value	Function/component	Terminal
4	- SA14 - Fuse 4 on fuse holder in engine compartment	15A	- J623 - Engine control unit - J624 - Engine control unit 2 (BGS) - J248 - Diesel direct injection system control unit - J361 - Simos control unit (injectors AUK)	87
5	- SA15 - Fuse 5 on fuse holder in engine compartment	15A 10A ¹⁾	- G70 - Air mass meter - J299 - Secondary air pump relay - N80 - Activated charcoal filter system solenoid valve 1 - N112 Secondary air inlet valve - Left electrohydraulic engine mounting solenoid valve - N144 Right electrohydraulic engine mounting solenoid valve - Variable intake manifold change-over valve - N145 Variable intake manifold change-over valve - N156 - N335 -	EKP
6	- SA16 - Fuse 6 on fuse holder in engine compartment	15A	- Z19 - Lambda probe heater - Z28 - Lambda probe 2 heater	87
7	- SA17 - Fuse 7 on fuse holder in engine compartment	15A	- Z29 - Lambda probe 1 heater after catalytic converter - Z30 - Lambda probe 2 heater after catalytic converter	EKP
8	- SA18 - Fuse 8 on fuse holder in engine compartment	5A	- J623 - Engine control unit	30
9	- SA19 - Fuse 9 on fuse holder in engine compartment	5A	- V7 - Radiator fan	87
10	- SA20 - Fuse 10 on fuse holder in engine compartment	10A	- J217 - Automatic gearbox control unit	87

1) Engine BGS

Audi A6

Fitting Locations

No. 802 / 9

Position of fuses, fuse holder, left-hand drive, from model year 2007

No.	Current Flow Diagram designation	Nominal value	Function/component	Terminal
1	- SA1 - Fuse 1 on fuse holder A	15A	- J569 - Brake servo relay	30
2	- SA2 - Fuse 2 on fuse holder A	20A 30A 15A	- J179 - Automatic glow period control unit J360 - High heat output relay J724 - Turbocharger 1 control unit N... - Ignition coils (BBJ, BDW, AUK) N... - Ignition coils (BAT, BXA, BDX) N144 - Left electrohydraulic engine mounting solenoid valve N145 - Right electrohydraulic engine mounting solenoid valve N184 - Clutch actuator breather valve V157 - Intake manifold flap motor V275 - Intake manifold flap 2 motor	87
3	- SA3 - Fuse 3 on fuse holder A	10A	- J151 - Continued coolant circulation relay (BBJ, BDW, BAT) J496 - Additional coolant pump relay (AUK, BXA) N205 - Inlet camshaft control valve 1 (AUK, BBJ, BDW, BAT, BXA) N208 - Inlet camshaft control valve 2 (AUK, BBJ, BDW, BAT) N276 - Fuel pressure regulating valve (BMK) N290 - Fuel metering valve (BMK) N318 - Exhaust camshaft control valve 1 (AUK, BBJ, BAT, BXA) N319 - Exhaust camshaft control valve 2 (AUK, BBJ, BDW, BAT) F... - Actuator for camshaft adjustment (BDX) F265 - Map-controlled engine cooling system thermostat (BXA) V157 - Intake manifold flap motor (BXA) V183 - Variable intake manifold motor (BXA)	87

Audi A6

Fitting Locations

No. 802 / 10

No.	Current Flow Diagram designation	Nominal value	Function/component	Terminal
4	- SA4-Fuse 4 on fuse holder A	15A	- J623 - Engine control unit J624 - Engine control unit 2	87
5	- SA5 - Fuse 5 on fuse holder A	15A	- G70 - Air mass meter J299 - Secondary air pump relay N80 - Activated charcoal filter system solenoid valve 1 N112 - Secondary air inlet valve N144 - Left electrohydraulic engine mounting solenoid valve N145 - Right electrohydraulic engine mounting solenoid valve N156 - Variable intake manifold change-over valve N335 - Variable intake manifold change-over valve	EKP
6	- SA6-Fuse 6 on fuse holder A	15A	- Z19 - Lambda probe heater Z28 - Lambda probe 2 heater	87
7	- SA7-Fuse 7 on fuse holder A	15A	- Z29 - Lambda probe 1 heater after catalytic converter Z30 - Lambda probe 2 heater after catalytic converter	EKP
8	- SA8 - Fuse 8 on fuse holder A	5A	- J623 - Engine control unit	30
9	- SA9 - Fuse 9 on fuse holder A	5A	- V7 - Radiator fan	87
10	- SA10 - Fuse 10 on fuse holder A	10A	- J217 - Automatic gearbox control unit	87

Audi A6

Fitting Locations

No. 802 / 11

Position of fuses, fuse holder, left-hand drive, from model year 2009

No.	Current Flow Diagram designation	Nominal value	Function/component	Terminal
1	- SA1 - Fuse 1 on fuse holder A	15A	- J569 - Brake servo relay	30
2	- SA2 - Fuse 2 on fuse holder A	20A 30A 15A	- J179 - Automatic glow period control unit ¹⁾ J360 - High heat output relay ¹⁾ J338 - Throttle valve module ¹⁾ J724 - Turbocharger 1 control unit N...-Ignition coils N75 - Charge pressure control solenoid valve ¹⁾ N79 - Heater element for crankcase breather ¹⁾ N144 - Left electrohydraulic engine mounting solenoid valve ¹⁾ N145 - Right electrohydraulic engine mounting solenoid valve ¹⁾ N275 - Air filter bypass flap valve ¹⁾ N345 - Exhaust gas recirculation cooler change-over valve ¹⁾ N428 - Valve for oil pressure control ¹⁾	87
3	- SA3 - Fuse 3 on fuse holder A	10A	- J151 - Continued coolant circulation relay J496-Additional coolant pump relay N144 - Left electrohydraulic engine mounting solenoid valve N145 - Right electrohydraulic engine mounting solenoid valve N205 - Inlet camshaft control valve 1 N208 - Inlet camshaft control valve 2 N276 - Fuel pressure regulating valve ¹⁾ N290 - Fuel metering valve ¹⁾ N318 - Exhaust camshaft control valve 1 N319 - Exhaust camshaft control valve 2 F... - Actuator for camshaft adjustment F265 - Map-controlled engine cooling system thermostat V157 - Intake manifold flap motor V183 - Variable intake manifold motor	87

1) models with diesel engine

Audi A6

Fitting Locations

No. 802 / 12

No.	Current Flow Diagram designation	Nominal value	Function/component	Terminal
4	- SA4-Fuse 4 on fuse holder A	15 A	- J623 - Engine control unit J624 - Engine control unit 2	87
5	- SA5 - Fuse 5 on fuse holder A	15 A	- J299 - Secondary air pump relay N80 - Activated charcoal filter system solenoid valve 1 N112 - Secondary air inlet valve N144 - Left electrohydraulic engine mounting solenoid valve N145 - Right electrohydraulic engine mounting solenoid valve N156 - Variable intake manifold change-over valve N249 - Turbocharger air recirculation valve N276 - Fuel pressure regulating valve N290 - Fuel metering valve N316 - Intake manifold flap valve N320 - Secondary air inlet valve 2 N335 - Variable intake manifold change-over valve N402 - Fuel metering valve 2 N428 - Valve for oil pressure control V144 - Fuel system diagnostic pump	EKP
6	- SA6-Fuse 6 on fuse holder A	15 A	- Z19 - Lambda probe heater Z28 - Lambda probe 2 heater	87
7	- SA7-Fuse 7 on fuse holder A	15 A	- Z29 - Lambda probe 1 heater after catalytic converter Z30 - Lambda probe 2 heater after catalytic converter	EKP
8	- SA8 - Fuse 8 on fuse holder A	5 A 20 A ¹⁾	- J623 - Engine control unit J832 - Relay for supplementary fuel pump ¹⁾	30
9	- SA9 - Fuse 9 on fuse holder A	5 A	- V7 - Radiator fan	87
10	- SA10 - Fuse 10 on fuse holder A	10 A	- J217 - Automatic gearbox control unit	87

1) models with diesel engine

Audi A6

Fitting Locations

No. 802 / 13

Location of fuses (SA), in electronics box left in plenum chamber, right-hand drive

Fuse colours

- 40 A - orange
- 30 A - green
- 25 A - white
- 20 A - yellow
- 15 A - blue
- 10 A - red
- 7.5 A - brown
- 5 A - beige
- 3 A - purple

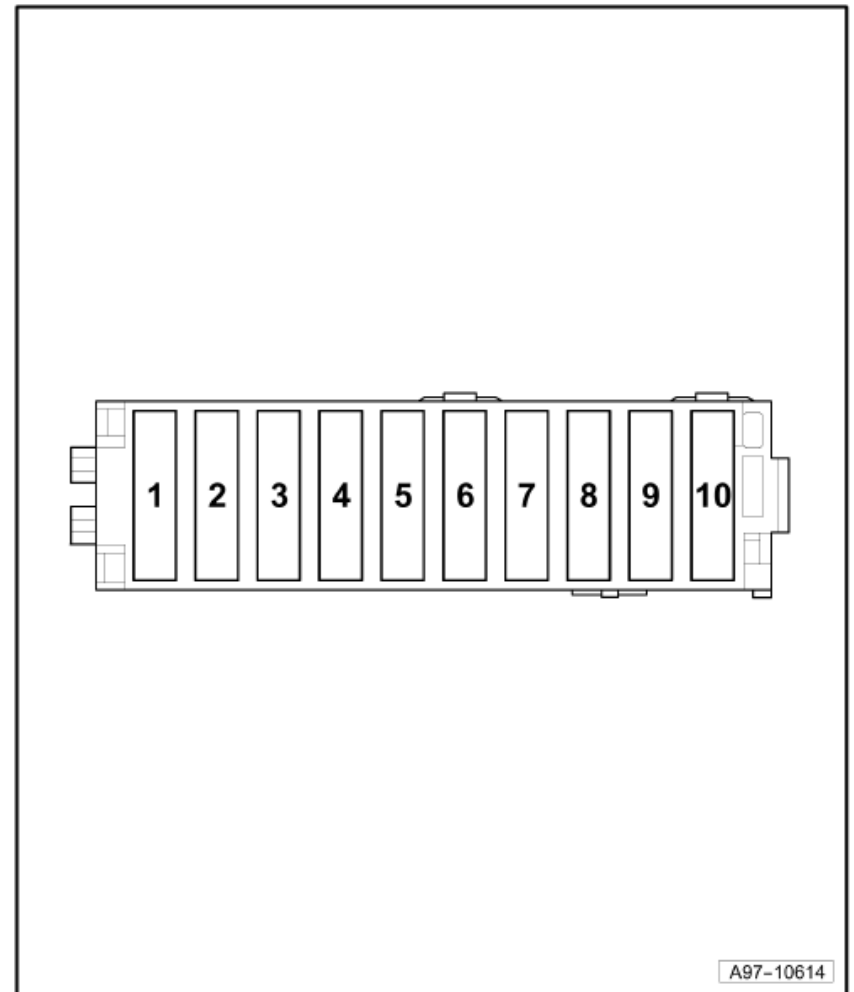

Audi A6

Fitting Locations

No. 802 / 14

Position of fuses, fuse holder, right-hand drive, from model year 2007

No.	Current Flow Diagram designation	Nominal value	Function/component	Terminal
1	- SA1 - Fuse 1 on fuse holder A	15A	- J569 - Brake servo relay	30
2	- SA2 - Fuse 2 on fuse holder A	20A 30A 15A	- J179 - Automatic glow period control unit J360 - High heat output relay J724 - Turbocharger 1 control unit N... - Ignition coils (BBJ, BDW, AUK) N... - Ignition coils (BAT, BXA, BDX) N144 - Left electrohydraulic engine mounting solenoid valve N145 - Right electrohydraulic engine mounting solenoid valve N184 - Clutch actuator breather valve V157 - Intake manifold flap motor V275 - Intake manifold flap 2 motor	87
3	- SA3 - Fuse 3 on fuse holder A	10A	- J151 - Continued coolant circulation relay (BBJ, BDW, BAT) J496 - Additional coolant pump relay (AUK, BXA) N205 - Inlet camshaft control valve 1 (AUK, BBJ, BDW, BAT, BXA) N208 - Inlet camshaft control valve 2 (AUK, BBJ, BDW, BAT) N276 - Fuel pressure regulating valve (BMK) N290 - Fuel metering valve (BMK) N318 - Exhaust camshaft control valve 1 (AUK, BBJ, BAT, BXA) N319 - Exhaust camshaft control valve 2 (AUK, BBJ, BDW, BAT) F... - Actuator for camshaft adjustment (BDX) F265 - Map-controlled engine cooling system thermostat (BXA) V157 - Intake manifold flap motor (BXA) V183 - Variable intake manifold motor (BXA)	87

Audi A6

Fitting Locations

No. 802 / 15

No.	Current Flow Diagram designation	Nominal value	Function/component	Terminal
4	- SA4-Fuse 4 on fuse holder A	15A	- J623 - Engine control unit J624 - Engine control unit 2	87
5	- SA5 - Fuse 5 on fuse holder A	15A	- G70 - Air mass meter J299 - Secondary air pump relay N80 - Activated charcoal filter system solenoid valve 1 N112 - Secondary air inlet valve N144 - Left electrohydraulic engine mounting solenoid valve N145 - Right electrohydraulic engine mounting solenoid valve N156 - Variable intake manifold change-over valve N335 - Variable intake manifold change-over valve	EKP
6	- SA6-Fuse 6 on fuse holder A	15A	- Z19 - Lambda probe heater Z28 - Lambda probe 2 heater	87
7	- SA7-Fuse 7 on fuse holder A	15A	- Z29 - Lambda probe 1 heater after catalytic converter Z30 - Lambda probe 2 heater after catalytic converter	EKP
8	- SA8 - Fuse 8 on fuse holder A	5A	- J623 - Engine control unit	30
9	- SA9 - Fuse 9 on fuse holder A	5A	- V7 - Radiator fan	87
10	- SA10 - Fuse 10 on fuse holder A	10A	- J217 - Automatic gearbox control unit	87

Audi A6

Fitting Locations

No. 802 / 16

Position of fuses, fuse holder, right-hand drive, from model year 2009

No.	Current Flow Diagram designation	Nominal value	Function/component	Terminal
1	- SA1 - Fuse 1 on fuse holder A	15A	- J569 - Brake servo relay	30
2	- SA2 - Fuse 2 on fuse holder A	20A 30A 15A	- J179 - Automatic glow period control unit ¹⁾ J360 - High heat output relay ¹⁾ J338 - Throttle valve module ¹⁾ J724 - Turbocharger 1 control unit N...-Ignition coils N75 - Charge pressure control solenoid valve ¹⁾ N79 - Heater element for crankcase breather ¹⁾ N144 - Left electrohydraulic engine mounting solenoid valve ¹⁾ N145 - Right electrohydraulic engine mounting solenoid valve ¹⁾ N275 - Air filter bypass flap valve ¹⁾ N345 - Exhaust gas recirculation cooler change-over valve ¹⁾ N428 - Valve for oil pressure control ¹⁾	87
3	- SA3 - Fuse 3 on fuse holder A	10A	- J151 - Continued coolant circulation relay J496-Additional coolant pump relay N144 - Left electrohydraulic engine mounting solenoid valve N145 - Right electrohydraulic engine mounting solenoid valve N205 - Inlet camshaft control valve 1 N208 - Inlet camshaft control valve 2 N276 - Fuel pressure regulating valve ¹⁾ N290 - Fuel metering valve ¹⁾ N318 - Exhaust camshaft control valve 1 N319 - Exhaust camshaft control valve 2 F... - Actuator for camshaft adjustment F265 - Map-controlled engine cooling system thermostat V157 - Intake manifold flap motor V183 - Variable intake manifold motor	87

1) models with diesel engine

Audi A6

Fitting Locations

No. 802 / 17

No.	Current Flow Diagram designation	Nominal value	Function/component	Terminal
4	- SA4-Fuse 4 on fuse holder A	15 A	- J623 - Engine control unit J624 - Engine control unit 2	87
5	- SA5 - Fuse 5 on fuse holder A	15 A	- J299 - Secondary air pump relay N80 - Activated charcoal filter system solenoid valve 1 N112 - Secondary air inlet valve N144 - Left electrohydraulic engine mounting solenoid valve N145 - Right electrohydraulic engine mounting solenoid valve N156 - Variable intake manifold change-over valve N249 - Turbocharger air recirculation valve N276 - Fuel pressure regulating valve N290 - Fuel metering valve N316 - Intake manifold flap valve N320 - Secondary air inlet valve 2 N335 - Variable intake manifold change-over valve N402 - Fuel metering valve 2 N428 - Valve for oil pressure control V144 - Fuel system diagnostic pump	EKP
6	- SA6-Fuse 6 on fuse holder A	15 A	- Z19 - Lambda probe heater Z28 - Lambda probe 2 heater	87
7	- SA7-Fuse 7 on fuse holder A	15 A	- Z29 - Lambda probe 1 heater after catalytic converter Z30 - Lambda probe 2 heater after catalytic converter	EKP
8	- SA8 - Fuse 8 on fuse holder A	5 A 20 A ¹⁾	- J623 - Engine control unit J832 - Relay for supplementary fuel pump ¹⁾	30
9	- SA9 - Fuse 9 on fuse holder A	5 A	- V7 - Radiator fan	87
10	- SA10 - Fuse 10 on fuse holder A	10 A	- J217 - Automatic gearbox control unit	87

1) models with diesel engine

Audi A6

Fitting Locations

No. 802 / 18

Location of fuses (SB), left dash panel

Fuse colours

- 40 A - orange
- 30 A - green
- 25 A - white
- 20 A - yellow
- 15 A - blue
- 10 A - red
- 7.5 A - brown
- 5 A - beige
- 3 A - purple

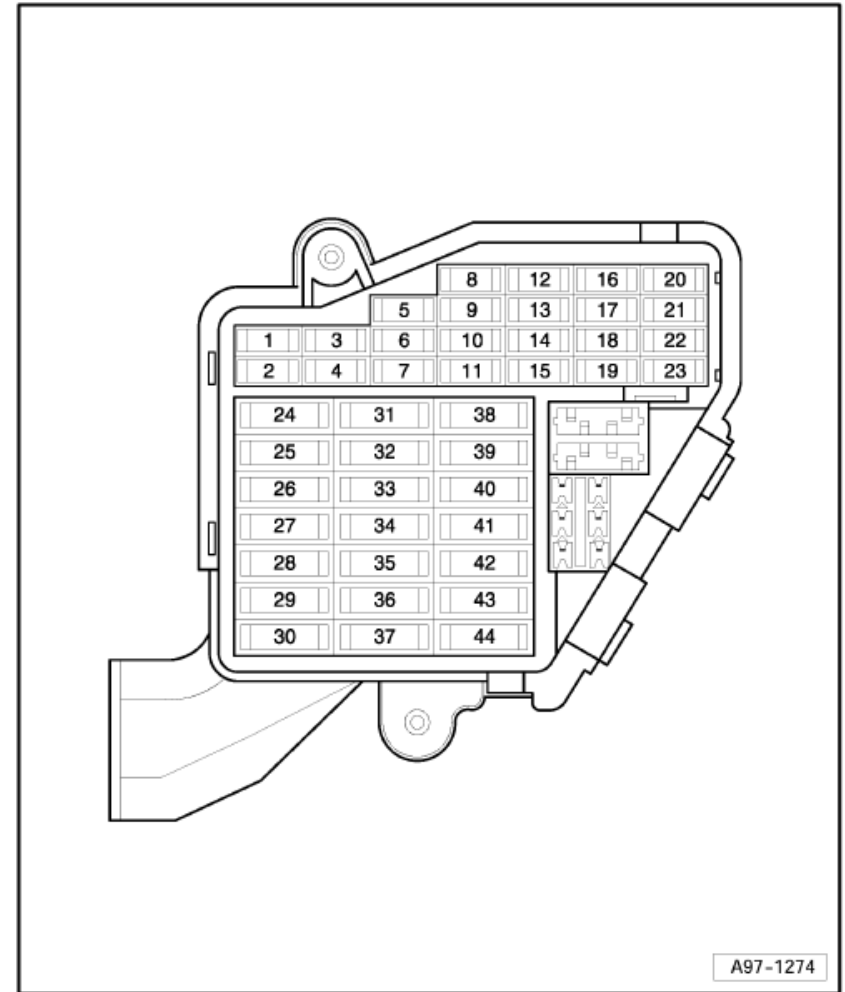

Audi A6

Fitting Locations

No. 802 / 19

Position of fuses, fuse holder, from model year 2005

No.	Current Flow Diagram designation	Nominal value	Function/component	Terminal
1	- Vacant			
2	- Vacant			
3	- SB3 - Fuse 3 on fuse holder	5A	- J361 - Simos control unit J248 - Diesel direct injection system control unit J623 - Engine control unit	15
4	- SB4 - Fuse 4 on fuse holder	5A	- G266-Oil level and oil temperature sender	15
5	- SB5 - Fuse 5 on fuse holder	5A	- G238 - Air quality sensor G395 - Refrigerant pressure and temperature sender	15
6	- SB6 - Fuse 6 on fuse holder	5A	- J104 - ABS control unit G476 - Clutch position sender	15
7	- SB7 - Fuse 7 on fuse holder	5A	- T16 - Diagnostic connector	15
8	- SB8 - Fuse 8 on fuse holder	5A	- J530 - Garage door operation control unit	15
9	- SB9 - Fuse 9 on fuse holder	5A	- Y7 - Automatic anti-dazzle interior mirror	15
10	- SB10 - Fuse 10 on fuse holder	5A	- J428 - Adaptive cruise control unit	15
11	- SB11 - Fuse 11 on fuse holder	5A	- R64 - Remote control receiver for auxiliary heating	30
12	- SB12 - Fuse 12 on fuse holder	10A	- T16 - Diagnostic connector	30
13	- SB13 - Fuse 13 on fuse holder	10A	- J527 - Steering column electronics control unit	30

Audi A6

Fitting Locations

No. 802 / 20

No.	Current Flow Diagram designation	Nominal value	Function/component	Terminal
15	- SB15 - Fuse 15 on fuse holder	10 A	- J285 - Control unit in dash panel insert	30
16	- SB16 - Fuse 16 on fuse holder	10 A	- R36 - Telephone transmitter and receiver unit	30
17	- SB17 - Fuse 17 on fuse holder	10 A	- J104 - ABS control unit	30
18	- SB18 - Fuse 18 on fuse holder	5 A	- left and right headlight with cornering lights	15
19	- SB19 - Fuse 19 on fuse holder	5 A	- G397 - Rain and light detector sensor	30
20	- SB20 - Fuse 20 on fuse holder	5 A	- Z20 - Left washer jet heater element Z21 - Right washer jet heater element	75
21	- SB21 - Fuse 21 on fuse holder	5 A	- R24 - Aerial amplifier	30
22	- Vacant			
23	- SB23 - Fuse 23 on fuse holder	5 A	- J540 - Electric park and handbrake control unit	30
24	- Vacant			
25	- Vacant			
26	- Vacant			
27	- Vacant			
28	- Vacant			
29	- Vacant			

Audi A6

Fitting Locations

No. 802 / 21

No.	Current Flow Diagram designation	Nominal value	Function/component	Terminal
30	- Vacant			
31	- SB31 - Fuse 31 on fuse holder	15 A	- F4 - Reversing light switch G70 - Air mass meter (TDI) J217 - Automatic gearbox control unit	15
32	- SB32 - Fuse 32 on fuse holder	30 A	- J519 - Onboard power supply control unit	30
33	- SB33 - Fuse 33 on fuse holder	25 A	- J519 - Onboard power supply control unit	30
34	- SB34 - Fuse 34 on fuse holder	25 A	- J519 - Onboard power supply control unit	30
35	- SB35 - Fuse 35 on fuse holder	20 A	- J364 - Auxiliary heater control unit	30
36	- SB36 - Fuse 36 on fuse holder	30 A	- J39 - Headlight washer system relay	30
37	- SB37 - Fuse 37 on fuse holder	25 A	- J104 - ABS control unit	30
38	- SB38 - Fuse 38 on fuse holder	30 A	- J400 - Wiper motor control unit	30
39	- SB39 - Fuse 39 on fuse holder	15 A	- J386 - Driver door control unit J388 - Rear left door control unit	30
40	- SB40 - Fuse 40 on fuse holder	25 A	- J4 - Dual tone horn relay H2 - Treble tone horn H7 - Bass tone horn	30
41	- SB41 - Fuse 41 on fuse holder	40 A	- J126 - Fresh air blower control unit	30
42	- SB42 - Fuse 42 on fuse holder	30 A	- E415 - Entry and start authorisation switch J518 - Entry and start authorisation control unit	30
43	- SB43 - Fuse 43 on fuse holder	15 A	- V43 - Rear window	35

Audi A6

Fitting Locations

No. 802 / 22

Position of fuses, fuse holder, left-hand drive, from model year 2007

No.	Current Flow Diagram designation	Nominal value	Function/component	Terminal
1	- Vacant			
2	- Vacant			
3	- SB3 - Fuse 3 on fuse holder B	5 A	- J623 - Engine control unit	15
4	- SB4 - Fuse 4 on fuse holder B	5 A	- G226 - Oil level and oil temperature sender	15
5	- SB5 - Fuse 5 on fuse holder B	5 A	- G238 - Air quality sensor G395 - Refrigerant pressure and temperature sender	15
6	- SB6 - Fuse 6 on fuse holder B	5 A	- J104 - ABS control unit G476 - Clutch position sender	15
7	- SB7 - Fuse 7 on fuse holder B	5 A	- T16 - Diagnostic connector	15
8	- SB8 - Fuse 8 on fuse holder B	5 A	- J530 - Garage door operation control unit	15
9	- SB9 - Fuse 9 on fuse holder B	5 A	- Y7 - Automatic anti-dazzle interior mirror	15
10	- SB10 - Fuse 10 on fuse holder B	5 A	- J428 - Adaptive cruise control unit	15
11	- SB11 - Fuse 11 on fuse holder B	5 A	- R64 - Remote control receiver for auxiliary heating	30
12	- SB12 - Fuse 12 on fuse holder B	10 A	- T16 - Diagnostic connector	30
13	- SB13 - Fuse 13 on fuse holder B	10 A	- J527 - Steering column electronics control unit	30
14	- SB14 - Fuse 14 on fuse holder B	5 A	- F - Brake light switch	30

Audi A6

Fitting Locations

No. 802 / 23

No.	Current Flow Diagram designation	Nominal value	Function/component	Terminal
15	- SB15 - Fuse 15 on fuse holder B	10 A	- J285 - Control unit in dash panel insert J533 - Data bus diagnostic interface	30
16	- SB16 - Fuse 16 on fuse holder B	10 A	- R36 - Telephone transmitter and receiver unit	30
17	- SB17 - Fuse 17 on fuse holder B	10 A	- J104 - ABS control unit	30
18	- SB18 - Fuse 18 on fuse holder B	5 A	- Left headlight with cornering lights J745 - Cornering light and headlight range control unit	15
19	- SB19 - Fuse 19 on fuse holder B	5 A	- G397 - Rain and light detector sensor	30
20	- SB20 - Fuse 20 on fuse holder B	5 A	- Z20 - Left washer jet heater element Z21 - Right washer jet heater element	75
21	- SB21 - Fuse 21 on fuse holder B	10 A	- Seat adjustment lumbar support driver seat	30
22	- Vacant			
23	- SB23 - Fuse 23 on fuse holder B	5 A	- J540 - Electric park and handbrake control unit	30
24	- Vacant			
25	- Vacant			
26	- Vacant			
27	- Vacant			
28	- Vacant			
29	- Vacant			
30	- Vacant			

Audi A6

Fitting Locations

No. 802 / 24

No.	Current Flow Diagram designation	Nominal value	Function/component	Terminal
31	- SB31 - Fuse 31 on fuse holder B	15 A	- F4 - Reversing light switch G70 - Air mass meter (TDI) J217 - Automatic gearbox control unit	15
32	- SB32 - Fuse 32 on fuse holder B	30 A	- J519 - Onboard power supply control unit	30
33	- SB33 - Fuse 33 on fuse holder B	25 A	- J519 - Onboard power supply control unit	30
34	- SB34 - Fuse 34 on fuse holder B	25 A	- J519 - Onboard power supply control unit	30
35	- SB35 - Fuse 35 on fuse holder B	20 A	- J364 - Auxiliary heater control unit	30
36	- SB36 - Fuse 36 on fuse holder B	30 A	- J39 - Headlight washer system relay	30
37	- SB37 - Fuse 37 on fuse holder B	25 A	- J104 - ABS control unit	30
38	- SB38 - Fuse 38 on fuse holder B	30 A	- J400 - Wiper motor control unit	30
39	- SB39 - Fuse 39 on fuse holder B	15 A	- J386 - Driver door control unit J388 - Rear left door control unit	30
40	- SB40 - Fuse 40 on fuse holder B	25 A	- J4 - Dual tone horn relay H2 - Treble tone horn H7 - Bass tone horn	30
41	- SB41 - Fuse 41 on fuse holder B	40 A	- J126 - Fresh air blower control unit	30
42	- SB42 - Fuse 42 on fuse holder B	30 A	- E415 - Entry and start authorisation switch J518 - Entry and start authorisation control unit	30
43	- SB43 - Fuse 43 on fuse holder B	15 A	- V12 - Rear window wiper motor	75
44	- SB44 - Fuse 44 on fuse holder B	35 A	- V26 - Rear left window regulator motor V147 - Driver side window regulator motor	30

Audi A6

Fitting Locations

No. 802 / 25

Position of fuses, fuse holder, left-hand drive, from model year 2009

No.	Current Flow Diagram designation	Nominal value	Function/component	Terminal
1	- Vacant			
2	- Vacant			
3	- SB3 - Fuse 3 on fuse holder B	5 A	- J623 - Engine control unit	15
4	- SB4 - Fuse 4 on fuse holder B	5 A	- G226 - Oil level and oil temperature sender	15
5	- SB5 - Fuse 5 on fuse holder B	5 A	- G238 - Air quality sensor G395 - Refrigerant pressure and temperature sender	15
6	- SB6 - Fuse 6 on fuse holder B	5 A	- J104 - ABS control unit G476 - Clutch position sender	15
7	- SB7 - Fuse 7 on fuse holder B	5 A	- T16 - Diagnostic connector	15
8	- SB8 - Fuse 8 on fuse holder B	5 A	- J530 - Garage door operation control unit	15
9	- SB9 - Fuse 9 on fuse holder B	5 A	- Y7 - Automatic anti-dazzle interior mirror	15
10	- SB10 - Fuse 10 on fuse holder B	5 A	- J428 - Adaptive cruise control unit	15
11	- SB11 - Fuse 11 on fuse holder B	5 A	- R64 - Remote control receiver for auxiliary heating	30
12	- SB12 - Fuse 12 on fuse holder B	10 A	- T16 - Diagnostic connector	30
13	- SB13 - Fuse 13 on fuse holder B	10 A	- J527 - Steering column electronics control unit	30
14	- Vacant			

Audi A6

Fitting Locations

No. 802 / 26

No.	Current Flow Diagram designation	Nominal value	Function/component	Terminal
15	- SB15 - Fuse 15 on fuse holder B	10 A	- J285 - Control unit in dash panel insert J533 - Data bus diagnostic interface	30
16	- SB16 - Fuse 16 on fuse holder B	5 A	- J794 - Control unit for information electronics 1 R126 - Telephone bracket	30
17	- SB17 - Fuse 17 on fuse holder B	10 A	- J104 - ABS control unit	30
18	- SB18 - Fuse 18 on fuse holder B	5 A	- Left headlight with cornering lights J745 - Cornering light and headlight range control unit	15
19	- SB19 - Fuse 19 on fuse holder B	5 A	- G397 - Rain and light detector sensor	30
20	- SB20 - Fuse 20 on fuse holder B	5 A	- Z20 - Left washer jet heater element Z21 - Right washer jet heater element	75
21	- SB21 - Fuse 21 on fuse holder B	10 A	- Seat adjustment lumbar support driver seat	30
22	- SB22 - Fuse 22 on fuse holder B	5 A	- J685 - Display unit for front information display and operating unit control unit	30
23	- SB23 - Fuse 23 on fuse holder B	5 A	- J540 - Electric park and handbrake control unit	30
24	- Vacant			
25	- Vacant			
26	- Vacant			
27	- Vacant			
28	- Vacant			
29	- Vacant			
30	- Vacant			

Audi A6

Fitting Locations

No. 802 / 27

No.	Current Flow Diagram designation	Nominal value	Function/component	Terminal
31	- SB31 - Fuse 31 on fuse holder B	15 A	- F4 - Reversing light switch G70 - Air mass meter (TDI) J217 - Automatic gearbox control unit	15
32	- SB32 - Fuse 32 on fuse holder B	30 A	- J519 - Onboard power supply control unit	30
33	- SB33 - Fuse 33 on fuse holder B	25 A	- J519 - Onboard power supply control unit	30
34	- SB34 - Fuse 34 on fuse holder B	25 A	- J519 - Onboard power supply control unit	30
35	- SB35 - Fuse 35 on fuse holder B	20 A	- J364 - Auxiliary heater control unit	30
36	- SB36 - Fuse 36 on fuse holder B	30 A	- J39 - Headlight washer system relay	30
37	- SB37 - Fuse 37 on fuse holder B	25 A	- J104 - ABS control unit	30
38	- SB38 - Fuse 38 on fuse holder B	30 A	- J400 - Wiper motor control unit	30
39	- SB39 - Fuse 39 on fuse holder B	15 A	- J386 - Driver door control unit J388 - Rear left door control unit	30
40	- SB40 - Fuse 40 on fuse holder B	25 A	- J4 - Dual tone horn relay H2 - Treble tone horn H7 - Bass tone horn	30
41	- SB41 - Fuse 41 on fuse holder B	40 A	- J126 - Fresh air blower control unit	30
42	- SB42 - Fuse 42 on fuse holder B	30 A	- E415 - Entry and start authorisation switch J518 - Entry and start authorisation control unit	30
43	- SB43 - Fuse 43 on fuse holder B	15 A	- V12 - Rear window wiper motor	75
44	- SB44 - Fuse 44 on fuse holder B	35 A	- V26 - Rear left window regulator motor V147 - Driver side window regulator motor	30

Audi A6

Fitting Locations

No. 802 / 28

Location of fuses (SB), right dash panel, right-hand drive

Fuse colours

- 40 A - orange
- 30 A - green
- 25 A - white
- 20 A - yellow
- 15 A - blue
- 10 A - red
- 7.5 A - brown
- 5 A - beige
- 3 A - purple

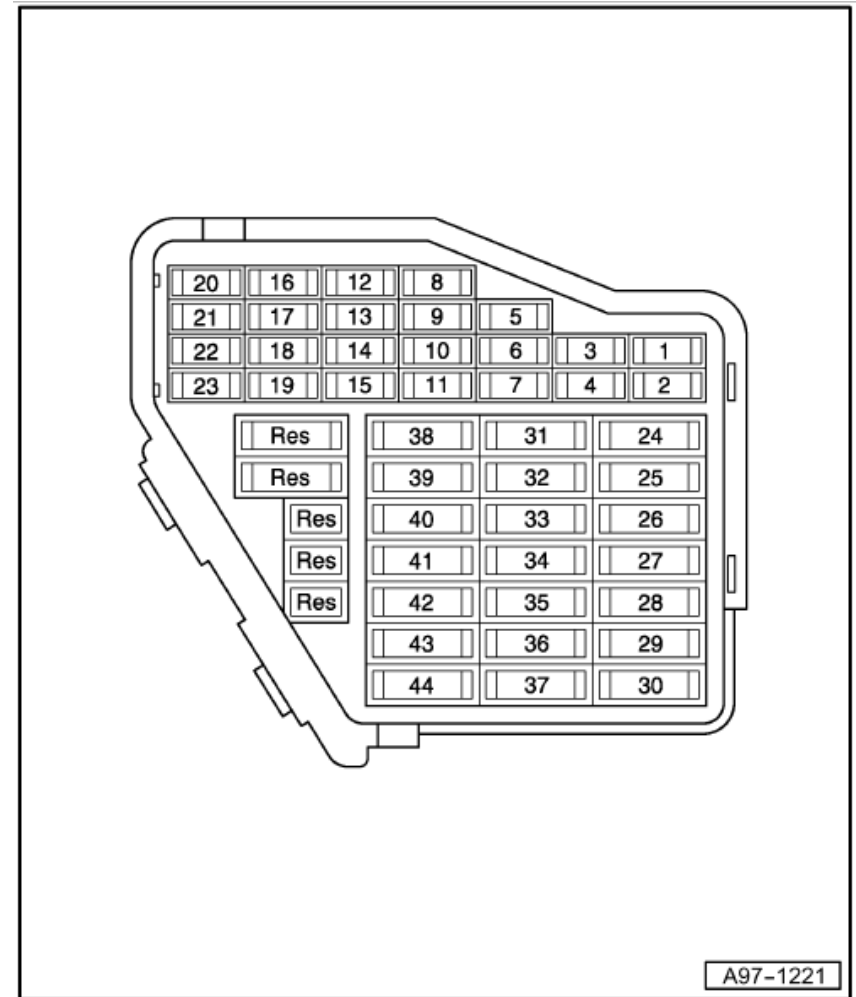

Audi A6

Fitting Locations

No. 802 / 29

Position of fuses, fuse holder, right-hand drive, from model year 2007

No.	Current Flow Diagram designation	Nominal value	Function/component	Terminal
1	- Vacant			
2	- Vacant			
3	- SB3 - Fuse 3 on fuse holder B	5 A	- J446 - Parking aid control unit	30
4	- SB4 - Fuse 4 on fuse holder B	5 A	- J446 - Parking aid control unit	15
5	- SB5 - Fuse 5 on fuse holder B	5 A	- G238 - Air quality sensor G395 - Refrigerant pressure and temperature sender	15
6	- SB6 - Fuse 6 on fuse holder B	5 A	- J587 - Selector lever sensors control unit	15
7	- SB7 - Fuse 7 on fuse holder B	5 A	- T16 - Diagnostic connector	15
8	- SB8 - Fuse 8 on fuse holder B	5 A	- Preparation for mobile telephone	15
9	- SB9 - Fuse 9 on fuse holder B	5 A	- E128 - Heated rear left seat switch with regulator E129 - Heated rear right seat switch with regulator	15
10	- SB10 - Fuse 10 on fuse holder B	10 A	- J759 - Lane departure warning control unit	15
11	- SB11 - Fuse 11 on fuse holder B	10 A	- J608 - Special vehicle control unit	30
12	- SB12 - Fuse 12 on fuse holder B	10 A	- T16 - Diagnostic connector	30
13	- SB13 - Fuse 13 on fuse holder B	10 A	- J527 - Steering column electronics control unit	30
14	- SB14 - Fuse 14 on fuse holder B	5 A	- F - Brake light switch	30

Audi A6

Fitting Locations

No. 802 / 30

No.	Current Flow Diagram designation	Nominal value	Function/component	Terminal
15	- SB15 - Fuse 15 on fuse holder B	10 A	- J285 - Control unit in dash panel insert J533 - Data bus diagnostic interface	30
16	- SB16 - Fuse 16 on fuse holder B	10 A	- T5k - Connector for optional equipment	30
17	- SB17 - Fuse 17 on fuse holder B	10 A	- J255 - Climatronic control unit	30
18	- SB18 - Fuse 18 on fuse holder B	5 A	- left and right headlight with cornering lights	15
19	- SB19 - Fuse 19 on fuse holder B	10 A	- Seat adjustment lumbar support driver seat	30
20	- SB20 - Fuse 20 on fuse holder B	5 A	- Z20 - Left washer jet heater element Z21 - Right washer jet heater element	75
21	- SB21 - Fuse 21 on fuse holder B	10 A	- J615 - Signal system operating unit control unit	15
22	- SB22 - Fuse 22 on fuse holder B	10 A	- T4ag - Connector for optional equipment	15
23	- SB23 - Fuse 23 on fuse holder B	5 A	- J540 - Electric park and handbrake control unit	30
24	- Vacant			
25	- Vacant			
26	- Vacant			
27	- Vacant			
28	- Vacant			
29	- Vacant			
30	- Vacant			

Audi A6

Fitting Locations

No. 802 / 31

No.	Current Flow Diagram designation	Nominal value	Function/component	Terminal
31	- Vacant			
32	- SB32 - Fuse 32 on fuse holder B	30 A	- J519 - Onboard power supply control unit	30
33	- SB33 - Fuse 33 on fuse holder B	25 A	- J519 - Onboard power supply control unit	30
34	- SB34 - Fuse 34 on fuse holder B	25 A	- J519 - Onboard power supply control unit	30
35	- SB35 - Fuse 35 on fuse holder B	30 A	- Z45 - Front left seat heating Z46 - Front right seat heating	30
36	- SB36 - Fuse 36 on fuse holder B	10 A	- J104 - ABS control unit	30
37	- SB37 - Fuse 37 on fuse holder B	25 A	- J104 - ABS control unit	30
38	- SB38 - Fuse 38 on fuse holder B	30 A	- J400 - Wiper motor control unit	30
39	- SB39 - Fuse 39 on fuse holder B	15 A	- J386 - Driver door control unit J388 - Rear left door control unit	30
40	- Vacant			
41	- SB41 - Fuse 41 on fuse holder B	40 A	- J126 - Fresh air blower control unit	30
42	- SB42 - Fuse 42 on fuse holder B	30 A	- E415 - Entry and start authorisation switch J518 - Entry and start authorisation control unit	30
43	- SB43 - Fuse 43 on fuse holder B	15 A	- V12 - Rear window wiper motor	75
44	- SB44 - Fuse 44 on fuse holder B	5 A	- J234 - Airbag control unit	15

Audi A6

Fitting Locations

No. 802 / 32

Position of fuses, fuse holder, right-hand drive, from model year 2009

No.	Current Flow Diagram designation	Nominal value	Function/component	Terminal
1	- Vacant			
2	- Vacant			
3	- SB3 - Fuse 3 on fuse holder B	5 A	- J446 - Parking aid control unit	30
4	- SB4 - Fuse 4 on fuse holder B	5 A	- J446 - Parking aid control unit	15
5	- SB5 - Fuse 5 on fuse holder B	5 A	- G238 - Air quality sensor G395 - Refrigerant pressure and temperature sender	15
6	- SB6 - Fuse 6 on fuse holder B	5 A	- J587 - Selector lever sensors control unit	15
7	- SB7 - Fuse 7 on fuse holder B	5 A	- T16 - Diagnostic connector	15
8	- SB8 - Fuse 8 on fuse holder B	5 A	- Preparation for mobile telephone	15
9	- SB9 - Fuse 9 on fuse holder B	5 A	- E128 - Heated rear left seat switch with regulator E129 - Heated rear right seat switch with regulator	15
10	- SB10 - Fuse 10 on fuse holder B	10 A	- J759 - Lane departure warning control unit	15
11	- SB11 - Fuse 11 on fuse holder B	10 A	- J608 - Special vehicle control unit	30
12	- SB12 - Fuse 12 on fuse holder B	10 A	- T16 - Diagnostic connector	30
13	- SB13 - Fuse 13 on fuse holder B	10 A	- J527 - Steering column electronics control unit	30
14	- Vacant			

Audi A6

Fitting Locations

No. 802 / 33

No.	Current Flow Diagram designation	Nominal value	Function/component	Terminal
15	- SB15 - Fuse 15 on fuse holder B	10 A	- J285 - Control unit in dash panel insert J533 - Data bus diagnostic interface	30
16	- SB16 - Fuse 16 on fuse holder B	10 A	- T5k - Connector for optional equipment	30
17	- SB17 - Fuse 17 on fuse holder B	10 A	- J255 - Climatronic control unit	30
18	- SB18 - Fuse 18 on fuse holder B	5 A	- left and right headlight with cornering lights	15
19	- SB19 - Fuse 19 on fuse holder B	10 A	- Seat adjustment lumbar support driver seat	30
20	- SB20 - Fuse 20 on fuse holder B	5 A	- Z20 - Left washer jet heater element Z21 - Right washer jet heater element	75
21	- SB21 - Fuse 21 on fuse holder B	10 A	- J615 - Signal system operating unit control unit	15
22	- SB22 - Fuse 22 on fuse holder B	10 A	- T4ag - Connector for optional equipment	15
23	- SB23 - Fuse 23 on fuse holder B	5 A	- J540 - Electric park and handbrake control unit	30
24	- Vacant			
25	- Vacant			
26	- Vacant			
27	- Vacant			
28	- Vacant			
29	- Vacant			
30	- Vacant			

Audi A6

Fitting Locations

No. 802 / 34

No.	Current Flow Diagram designation	Nominal value	Function/component	Terminal
31	- Vacant			
32	- SB32 - Fuse 32 on fuse holder B	30 A	- J519 - Onboard power supply control unit	30
33	- SB33 - Fuse 33 on fuse holder B	25 A	- J519 - Onboard power supply control unit	30
34	- SB34 - Fuse 34 on fuse holder B	25 A	- J519 - Onboard power supply control unit	30
35	- SB35 - Fuse 35 on fuse holder B	30 A	- Z45 - Front left seat heating Z46 - Front right seat heating	30
36	- SB36 - Fuse 36 on fuse holder B	10 A	- J104 - ABS control unit	30
37	- SB37 - Fuse 37 on fuse holder B	25 A	- J104 - ABS control unit	30
38	- SB38 - Fuse 38 on fuse holder B	30 A	- J400 - Wiper motor control unit	30
39	- SB39 - Fuse 39 on fuse holder B	15 A	- J386 - Driver door control unit J388 - Rear left door control unit	30
40	- SB40 - Fuse 40 on fuse holder B	5 A	J685 - Display unit for front information display and operating unit control unit	30
41	- SB41 - Fuse 41 on fuse holder B	40 A	- J126 - Fresh air blower control unit	30
42	- SB42 - Fuse 42 on fuse holder B	30 A	- E415 - Entry and start authorisation switch J518 - Entry and start authorisation control unit	30
43	- SB43 - Fuse 43 on fuse holder B	15 A	- V12 - Rear window wiper motor	75
44	- SB44 - Fuse 44 on fuse holder B	5 A	- J234 - Airbag control unit	15

Audi A6

Fitting Locations

No. 802 / 35

Location of fuses (SC), right dash panel

Fuse colours

40 A - orange

30 A - green

25 A - white

20 A - yellow

15 A - blue

10 A - red

7.5 A - brown

5 A - beige

3 A - purple

1 - Fuse carrier ST1 (black)

2 - Fuse carrier ST2 (brown)

3 - Fuse carrier ST3 (red)

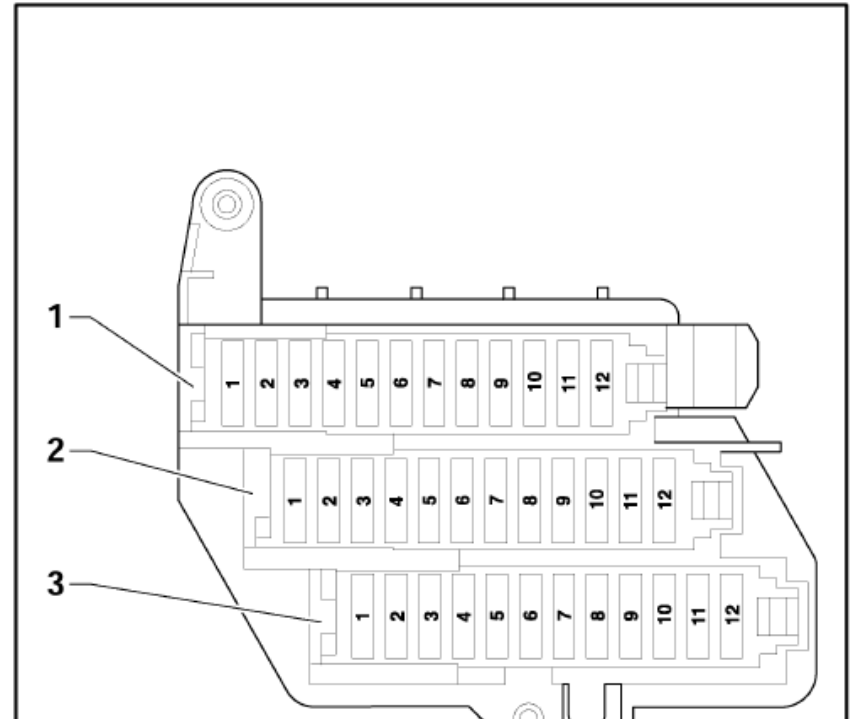

Audi A6

Fitting Locations

No. 802 / 36

Position of fuses, fuse holder, from model year 2005

No.	Current Flow Diagram designation Fuse carrier ST1 (black)	Nominal value	Function/component	Terminal
1	- SC1 - Fuse 1 on fuse holder	5A ¹⁾ 15A ²⁾	- R173 Traffic data aerial ¹⁾ - Aerial reader unit for keyless entry system ²⁾ J723 -	30
2	- SC2 - Fuse 2 on fuse holder	20A	- U1 - Cigarette lighter	30
3	- SC3 - Fuse 3 on fuse holder	5A	- J502 - Tyre pressure monitor control unit	30
4	- SC4 - Fuse 4 on fuse holder	20A	- U5 - 12 V socket	30
5	- SC5 - Fuse 5 on fuse holder	15A	- J520 - Onboard supply control unit 2	30
6	- SC6 - Fuse 6 on fuse holder	15A	- J387 - Front passenger door control unit J389 - Rear right door control unit	30
7	- SC7 - Fuse 7 on fuse holder	20A	- J245 - Sliding sunroof adjustment control unit	30
8	- SC8 - Fuse 8 on fuse holder	10A	- J255 - Climatronic control unit	30
9	- SC9 - Fuse 9 on fuse holder	30A	- J255 - Climatronic control unit	30
10	- SC10 - Fuse 10 on fuse holder	10A 5A	- J523 - Front information display and operating unit control unit	30
11	- SC11 - Fuse 11 on fuse holder	15A	- J197 - Adaptive suspension control unit	30
12	- SC12 - Fuse 12 on fuse holder	5A	- R118 Media player in position 1 - Media player in position 2 R119 -	30

1) up to October 2005

2) from November 2005

Audi A6

Fitting Locations

No. 802 / 37

No.	Current Flow Diagram designation Fuse carrier ST2 (brown)	Nominal value	Function/component	Terminal
1	- SC1 - Fuse 1 on fuse holder	20A	- G23 - Fuel pump (BMK, BNG) - G6 - Fuel pump (BBJ, BAT) - J538 Fuel pump control unit (AUK)	87
2	- SC2 - Fuse 2 on fuse holder	10A	- U10 - Trailer socket ¹⁾	15
3	- Vacant			
4	- Vacant			
5	- SC5 - Fuse 5 on fuse holder	5A	- J197 - Adaptive suspension control unit	15
6	- SC6 - Fuse 6 on fuse holder	5A	- J587 - Selector lever sensors control unit	15
7	- SC7 - Fuse 7 on fuse holder	5A	- J446 - Parking aid control unit	15
8	- SC8 - Fuse 8 on fuse holder	5A	- J533 - Data bus diagnostic interface	15
9	- SC9 - Fuse 9 on fuse holder	5A	- J431 - Headlight range control, control unit	15
10	- SC10 - Fuse 10 on fuse holder	5A	- J234 - Airbag control unit - K145 Front passenger side airbag deactivated warning lamp -	15
11	- SC11 - Fuse 11 on fuse holder	5A	- E128 Heated rear left seat switch with regulator - Heated rear right seat switch with regulator - E129 -	15
12	- Vacant			

¹⁾ no longer fitted, phased from October 2004

Audi A6

Fitting Locations

No. 802 / 38

No.	Current Flow Diagram designation Fuse carrier ST3 (red)	Nominal value	Function/component	Terminal
1	- SC1 - Fuse 1 on fuse holder	25A	- J615 - Signal system operating unit control unit	30
2	- SC2 - Fuse 2 on fuse holder	15A	- J615 - Signal system operating unit control unit	30
3	- SC3 - Fuse 3 on fuse holder	15A	- J615 - Signal system operating unit control unit	30
4	- SC4 - Fuse 4 on fuse holder	5A 10A 10A 10A	G41 - Taxi meter - G24 - Tachograph J608 - Special vehicle control unit J615 - Signal system operating unit control unit	15
5	- SC5 - Fuse 5 on fuse holder	10A 15A 25A	J608 - Special vehicle control unit - J608 - Special vehicle control unit J608 - Special vehicle control unit	30
6	- SC6 - Fuse 6 on fuse holder	5A 10A 15A	- J608 - Special vehicle control unit R8 - Two-way radio T5i - Connector for optional equipment	30
7	- SC7 - Fuse 7 on fuse holder	5A 10A 25A	- G41 - Taxi meter G24 - Tachograph J476 - Personal danger alarm control unit	30
8	- SC8 - Fuse 8 on fuse holder	20A 10A 15A	- U5 - 12 V socket U19 - 12 V socket 3 T4ag - Connector for optional equipment	30
9	- SC9 - Fuse 9 on fuse holder	15A	- T5k - Connector for optional equipment	30
10	- Vacant			
11	- Vacant			
12	- Vacant			

Audi A6

Fitting Locations

No. 802 / 39

Position of fuses, fuse holder, left-hand drive, from model year 2007

No.	Current Flow Diagram designation Fuse carrier ST1 (black)	Nominal value	Function/component	Terminal
1	- SC1 - Fuse 1 on fuse holder C	15 A	- J723 - Aerial reader unit for keyless entry system	30
2	- SC2 - Fuse 2 on fuse holder C	20 A	- U1 - Cigarette lighter	30
3	- SC3 - Fuse 3 on fuse holder C	5 A	- J502 - Tyre pressure monitor control unit	30
4	- SC4 - Fuse 4 on fuse holder C	20 A	- U5 - 12 V socket (USA)	30
5	- SC5-Fuse 5 on fuse holder C	15 A	- J520 - Onboard supply control unit 2	30
6	- SC6 - Fuse 6 on fuse holder C	15 A	- J387 - Front passenger side door control unit J389 - Rear right door control unit	30
7	- SC7 - Fuse 7 on fuse holder C	20 A	- J245 - Sliding sunroof adjustment control unit	30
8	- SC8 - Fuse 8 on fuse holder C	10 A	- J255 - Climatronic control unit	30
9	- SC9 - Fuse 9 on fuse holder C	30 A	- J255 - Climatronic control unit Z45 - Front left seat heating Z46 - Front right seat heating	30
10	- SC10 - Fuse 10 on fuse holder C	10 A ¹⁾ 5 A	- J523 - Front information display and operating unit control unit	30
11	- SC11 - Fuse 11 on fuse holder C	10 A	- Seat adjustment lumbar support front passenger seat	30
12	- SC12 - Fuse 12 on fuse holder C	5 A	- R118 - Media player in position 1 R119 - Media player in position 2 (up to October 2006) R199 - Connection for external audio source (from November 2006)	30

1) MMI Basic

Audi A6

Fitting Locations

No. 802 / 40

No.	Current Flow Diagram designation Fuse carrier ST2 (brown)	Nominal value	Function/component	Terminal
1	- SC1 - Fuse 1 on fuse holder C	20 A 30 A	- G23 - Fuel pump (BMK, BNG) G6 - Fuel pump (BBJ, BAT) J538 - Fuel pump control unit (AUK, BVJ, BXA, BDX)	87
2	- SC2 - Fuse 2 on fuse holder C	15 A	- J197 - Adaptive suspension control unit	30
3	- SC3 - Fuse 3 on fuse holder C	10 A	- J759 - Lane departure warning control unit	15
4	- Vacant			
5	- SC5-Fuse 5 on fuse holder C	5 A	- J197 - Adaptive suspension control unit	15
6	- SC6 - Fuse 6 on fuse holder C	5 A	- J587 - Selector lever sensors control unit F47 - Brake pedal switch	15
7	- SC7 - Fuse 7 on fuse holder C	5 A	- J446 - Parking aid control unit	15
8	- SC8 - Fuse 8 on fuse holder C	5 A	- J533 - Data bus diagnostic interface	15
9	- SC9 - Fuse 9 on fuse holder C	5 A	- Right headlight J431 - Headlight range control, control unit J745 - Cornering light and headlight range control unit	15
10	- SC10 - Fuse 10 on fuse holder C	5 A	- J234 - Airbag control unit	15
11	- SC11 - Fuse 11 on fuse holder C	5 A	- E128 - Heated rear left seat switch with regulator E129 - Heated rear right seat switch with regulator	15
12	- SC12 - Fuse 12 on fuse holder C	5 A	- Preparation for mobile telephone	15

Audi A6

Fitting Locations

No. 802 / 41

No.	Current Flow Diagram designation Fuse carrier ST3 (red)	Nominal value	Function/component	Terminal
1	- SC1 - Fuse 1 on fuse holder C	25 A	- J615 - Signal system operating unit control unit	30
2	- SC2 - Fuse 2 on fuse holder C	15 A	- J615 - Signal system operating unit control unit	30
3	- SC3 - Fuse 3 on fuse holder C	15 A	- J615 - Signal system operating unit control unit	30
4	- SC4 - Fuse 4 on fuse holder C	5 A 10 A 10 A 10 A	- G41 - Taxi meter G24 - Tachograph J608 - Special vehicle control unit J615 - Signal system operating unit control unit	15
5	- SC5-Fuse 5 on fuse holder C	10 A 15 A 25 A	- J608 - Special vehicle control unit J608 - Special vehicle control unit J608 - Special vehicle control unit	30
6	- SC6 - Fuse 6 on fuse holder C	5 A 10 A 15 A	- J608 - Special vehicle control unit R8 - Two-way radio T5i - Connector for optional equipment	30
7	- SC7 - Fuse 7 on fuse holder C	5 A 10 A 15 A	- G41 - Taxi meter G24 - Tachograph J476 - Personal danger alarm control unit	30
8	- SC8 - Fuse 8 on fuse holder C	20 A 10 A 15 A	- U5 - 12 V socket U19 - 12 V socket 3 T4ag - Connector for optional equipment	30
9	- SC9 - Fuse 9 on fuse holder C	15 A	- T5k - Connector for optional equipment	30
10	- Vacant			
11	- Vacant			
12	- Vacant			

Audi A6

Fitting Locations

No. 802 / 42

Position of fuses, fuse holder, left-hand drive, from model year 2009

No.	Current Flow Diagram designation Fuse carrier ST1 (black)	Nominal value	Function/component	Terminal
1	- SC1 - Fuse 1 on fuse holder C	15 A	- J723 - Aerial reader unit for keyless entry system	30
2	- SC2 - Fuse 2 on fuse holder C	20 A	- U1 - Cigarette lighter	30
3	- SC3 - Fuse 3 on fuse holder C	5 A	- J502 - Tyre pressure monitor control unit	30
4	- SC4 - Fuse 4 on fuse holder C	20 A	- U5 - 12 V socket (USA)	30
5	- SC5-Fuse 5 on fuse holder C	15 A	- J520 - Onboard supply control unit 2	30
6	- SC6 - Fuse 6 on fuse holder C	15 A	- J387 - Front passenger side door control unit J389 - Rear right door control unit	30
7	- SC7 - Fuse 7 on fuse holder C	20 A	- J245 - Sliding sunroof adjustment control unit	30
8	- SC8 - Fuse 8 on fuse holder C	10 A	- J255 - Climatronic control unit	30
9	- SC9 - Fuse 9 on fuse holder C	30 A	- J255 - Climatronic control unit Z45 - Front left seat heating Z46 - Front right seat heating	30
10	- SC10 - Fuse 10 on fuse holder C	7,5 A	- J794 - Control unit for information electronics 1	30
11	- SC11 - Fuse 11 on fuse holder C	10 A	- Seat adjustment lumbar support front passenger seat	30
12	- SC12 - Fuse 12 on fuse holder C	5 A	- R7 - DVD player R41 - CD changer	30

Audi A6

Fitting Locations

No. 802 / 43

No.	Current Flow Diagram designation Fuse carrier ST2 (brown)	Nominal value	Function/component	Terminal
1	- SC1 - Fuse 1 on fuse holder C	20 A 30 A	- G23 - Fuel pump G6 - Fuel pump J538 - Fuel pump control unit	87
2	- SC2 - Fuse 2 on fuse holder C	15 A	- J197 - Adaptive suspension control unit	30
3	- SC3 - Fuse 3 on fuse holder C	10 A	- J759 - Lane departure warning control unit	15
4	- SC4 - Fuse 4 on fuse holder C	5 A	- J769 - Lane change assist control unit	15
5	- SC5-Fuse 5 on fuse holder C	5 A	- J197 - Adaptive suspension control unit	15
6	- SC6 - Fuse 6 on fuse holder C	5 A	- J587 - Selector lever sensors control unit F47 - Brake pedal switch	15
7	- SC7 - Fuse 7 on fuse holder C	5 A	- J446 - Parking aid control unit	15
8	- SC8 - Fuse 8 on fuse holder C	5 A	- J533 - Data bus diagnostic interface	15
9	- SC9 - Fuse 9 on fuse holder C	5 A	- Right headlight J431 - Headlight range control, control unit J745 - Cornering light and headlight range control unit	15
10	- SC10 - Fuse 10 on fuse holder C	5 A	- J234 - Airbag control unit	15
11	- SC11 - Fuse 11 on fuse holder C	5 A	- E128 - Heated rear left seat switch with regulator E129 - Heated rear right seat switch with regulator	15
12	- SC12 - Fuse 12 on fuse holder C	5 A	- Preparation for mobile telephone	15

Audi A6

Fitting Locations

No. 802 / 44

No.	Current Flow Diagram designation Fuse carrier ST3 (red)	Nominal value	Function/component	Terminal
1	- SC1 - Fuse 1 on fuse holder C	25 A	- J615 - Signal system operating unit control unit	30
2	- SC2 - Fuse 2 on fuse holder C	15 A	- J615 - Signal system operating unit control unit	30
3	- SC3 - Fuse 3 on fuse holder C	15 A	- J615 - Signal system operating unit control unit	30
4	- SC4 - Fuse 4 on fuse holder C	5 A 10 A 10 A 10 A	- G41 - Taxi meter G24 - Tachograph J608 - Special vehicle control unit J615 - Signal system operating unit control unit	15
5	- SC5-Fuse 5 on fuse holder C	10 A 15 A 25 A	- J608 - Special vehicle control unit J608 - Special vehicle control unit J608 - Special vehicle control unit	30
6	- SC6 - Fuse 6 on fuse holder C	5 A 10 A 15 A	- J608 - Special vehicle control unit R8 - Two-way radio T5i - Connector for optional equipment	30
7	- SC7 - Fuse 7 on fuse holder C	5 A 10 A 15 A	- G41 - Taxi meter G24 - Tachograph J476 - Personal danger alarm control unit	30
8	- SC8 - Fuse 8 on fuse holder C	20 A 10 A 15 A	- U5 - 12 V socket U19 - 12 V socket 3 T4ag - Connector for optional equipment	30
9	- SC9 - Fuse 9 on fuse holder C	15 A	- T5k - Connector for optional equipment	30
10	- Vacant			
11	- Vacant			
12	- Vacant			

Audi A6

Fitting Locations

No. 802 / 45

Location of fuses (SC), left dash panel, right-hand drive

Fuse colours

40 A - orange

30 A - green

25 A - white

20 A - yellow

15 A - blue

10 A - red

7.5 A - brown

5 A - beige

3 A - purple

1 - Fuse carrier ST1 (black)

2 - Fuse carrier ST2 (brown)

3 - Fuse carrier ST3 (red)

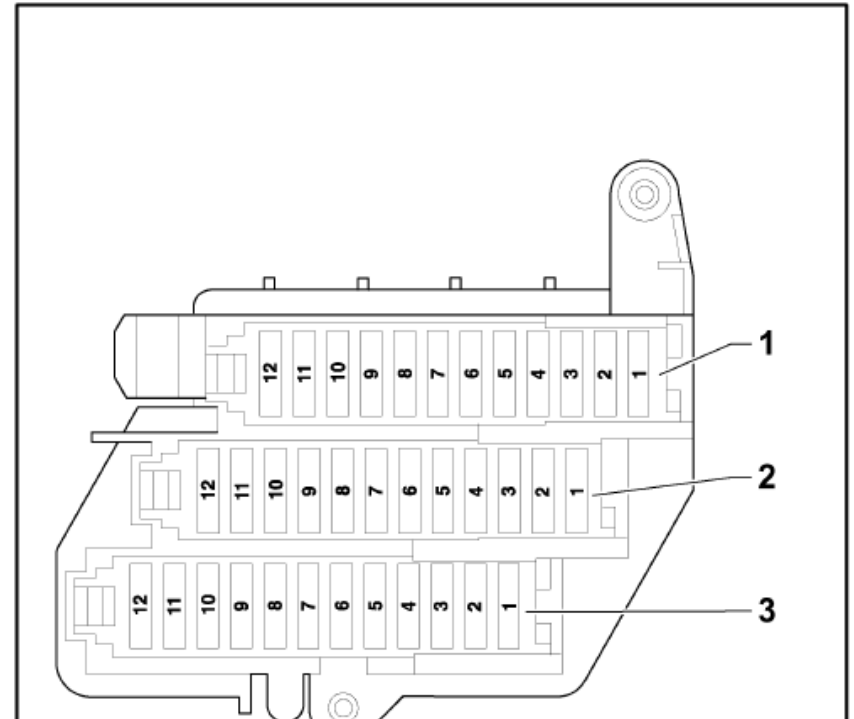

Audi A6

Fitting Locations

No. 802 / 46

Position of fuses, fuse holder, right-hand drive, from model year 2007

No.	Current Flow Diagram designation Fuse carrier ST1 (black)	Nominal value	Function/component	Terminal
1	- Vacant			
2	- SC2 - Fuse 2 on fuse holder C	15 A	- J723 - Aerial reader unit for keyless entry system	30
3	- SC3 - Fuse 3 on fuse holder C	5 A	- J502 - Tyre pressure monitor control unit	30
4	- SC4 - Fuse 4 on fuse holder C	10 A	- Seat adjustment lumbar support front passenger seat	30
5	- SC5-Fuse 5 on fuse holder C	15 A	- J520 - Onboard supply control unit 2	30
6	- SC6 - Fuse 6 on fuse holder C	15 A	- J387 - Front passenger side door control unit J389 - Rear right door control unit	30
7	- SC7 - Fuse 7 on fuse holder C	20 A	- J245 - Sliding sunroof adjustment control unit	30
8	- SC8 - Fuse 8 on fuse holder C	35 A	- V26 - Rear left window regulator motor V147 - Driver side window regulator motor	30
9	- Vacant			
10	- SC10 - Fuse 10 on fuse holder C	10 A ¹⁾ 5 A	- J523 - Front information display and operating unit control unit	30
11	- SC11 - Fuse 11 on fuse holder C	15 A	- J197 - Adaptive suspension control unit	30
12	- SC12 - Fuse 12 on fuse holder C	5 A	- R118 - Media player in position 1 R119 - Media player in position 2 (up to October 2006) R199 - Connection for external audio source (from November 2006)	30

1) MMI Basic

Audi A6

Fitting Locations

No. 802 / 47

No.	Current Flow Diagram designation Fuse carrier ST2 (brown)	Nominal value	Function/component	Terminal
1	- SC1 - Fuse 1 on fuse holder C	20 A 30 A	- G23 - Fuel pump (BMK, BNG) G6 - Fuel pump (BBJ, BAT) J538 - Fuel pump control unit (AUK, BVJ, BXA, BDX)	87
2	- Vacant			
3	- SC3 - Fuse 3 on fuse holder C	5 A	- J530 - Garage door operation control unit	15
4	- SC4 - Fuse 4 on fuse holder C	5 A	- J428 - Adaptive cruise control unit	15
5	- SC5-Fuse 5 on fuse holder C	5 A	- J197 - Adaptive suspension control unit	15
6	- SC6 - Fuse 6 on fuse holder C	5 A	- J623 - Engine control unit	15
7	- SC7 - Fuse 7 on fuse holder C	5 A	- G226 - Oil level and oil temperature sender	15
8	- SC8 - Fuse 8 on fuse holder C	5 A	- J533 - Data bus diagnostic interface	15
9	- SC9 - Fuse 9 on fuse holder C	5 A	- Left headlight J431 - Headlight range control, control unit J745 - Cornering light and headlight range control unit	15
10	- SC10 - Fuse 10 on fuse holder C	5 A	- J104 - ABS control unit G476 - Clutch position sender	15
11	- SC11 - Fuse 11 on fuse holder C	5 A	- Y7 - Automatic anti-dazzle interior mirror	15
12	- SC12 - Fuse 12 on fuse holder C	15 A	- F4 - Reversing light switch G70 - Air mass meter (TDI) J217 - Automatic gearbox control unit	15

Audi A6

Fitting Locations

No. 802 / 48

No.	Current Flow Diagram designation Fuse carrier ST3 (red)	Nominal value	Function/component	Terminal
1	- Vacant			
2	- SC2 - Fuse 2 on fuse holder C	5 A	- G397 - Rain and light detector sensor	30
3	- SC3 - Fuse 3 on fuse holder C	20 A	- J364 - Auxiliary heater control unit	30
4	- SC4 - Fuse 4 on fuse holder C	5 A	- R64 - Remote control receiver for auxiliary heating	30
5	- SC5-Fuse 5 on fuse holder C	30 A	- J39 - Headlight washer system relay	30
6	- SC6 - Fuse 6 on fuse holder C	25 A	- J608 - Special vehicle control unit	30
7	- SC7 - Fuse 7 on fuse holder C	10 A	- R36 - Telephone transmitter and receiver unit	30
8	- SC8 - Fuse 8 on fuse holder C	25 A	- J4 - Dual tone horn relay H2 - Treble tone horn H7 - Bass tone horn	30
9	- SC9 - Fuse 9 on fuse holder C	15 A	- J476 - Personal danger alarm control unit	30
10	- SC10 - Fuse 10 on fuse holder C	15 A	- T4ag - Connector for optional equipment	30
11	- Vacant			
12	- Vacant			

Audi A6

Fitting Locations

No. 802 / 49

Position of fuses, fuse holder, right-hand drive, from model year 2009

No.	Current Flow Diagram designation Fuse carrier ST1 (black)	Nominal value	Function/component	Terminal
1	- Vacant			
2	- SC2 - Fuse 2 on fuse holder C	15 A	- J723 - Aerial reader unit for keyless entry system	30
3	- SC3 - Fuse 3 on fuse holder C	5 A	- J502 - Tyre pressure monitor control unit	30
4	- SC4 - Fuse 4 on fuse holder C	10 A	- Seat adjustment lumbar support front passenger seat	30
5	- SC5-Fuse 5 on fuse holder C	15 A	- J520 - Onboard supply control unit 2	30
6	- SC6 - Fuse 6 on fuse holder C	15 A	- J387 - Front passenger side door control unit J389 - Rear right door control unit	30
7	- SC7 - Fuse 7 on fuse holder C	20 A	- J245 - Sliding sunroof adjustment control unit	30
8	- SC8 - Fuse 8 on fuse holder C	35 A	- V26 - Rear left window regulator motor V147 - Driver side window regulator motor	30
9	- Vacant			
10	- SC10 - Fuse 10 on fuse holder C	7,5 A	- J794 - Control unit for information electronics 1	30
11	- SC11 - Fuse 11 on fuse holder C	15 A	- J197 - Adaptive suspension control unit	30
12	- SC12 - Fuse 12 on fuse holder C	5 A	- R7 - DVD player R41 - CD changer	30

Audi A6

Fitting Locations

No. 802 / 50

No.	Current Flow Diagram designation Fuse carrier ST2 (brown)	Nominal value	Function/component	Terminal
1	- SC1 - Fuse 1 on fuse holder C	20 A 30 A	- G23 - Fuel pump G6 - Fuel pump J538 - Fuel pump control unit	87
2	- SC2 - Fuse 2 on fuse holder C	5 A	- J769 - Lane change assist control unit	15
3	- SC3 - Fuse 3 on fuse holder C	5 A	- J530 - Garage door operation control unit	15
4	- SC4 - Fuse 4 on fuse holder C	5 A	- J428 - Adaptive cruise control unit	15
5	- SC5-Fuse 5 on fuse holder C	5 A	- J197 - Adaptive suspension control unit	15
6	- SC6 - Fuse 6 on fuse holder C	5 A	- J623 - Engine control unit	15
7	- SC7 - Fuse 7 on fuse holder C	5 A	- G226 - Oil level and oil temperature sender	15
8	- SC8 - Fuse 8 on fuse holder C	5 A	- J533 - Data bus diagnostic interface	15
9	- SC9 - Fuse 9 on fuse holder C	5 A	- Left headlight J431 - Headlight range control, control unit J745 - Cornering light and headlight range control unit	15
10	- SC10 - Fuse 10 on fuse holder C	5 A	- J104 - ABS control unit G476 - Clutch position sender	15
11	- SC11 - Fuse 11 on fuse holder C	5 A	- Y7 - Automatic anti-dazzle interior mirror	15
12	- SC12 - Fuse 12 on fuse holder C	15 A	- F4 - Reversing light switch G70 - Air mass meter (TDI) J217 - Automatic gearbox control unit	15

Audi A6

Fitting Locations

No. 802 / 51

No.	Current Flow Diagram designation Fuse carrier ST3 (red)	Nominal value	Function/component	Terminal
1	- Vacant			
2	- SC2 - Fuse 2 on fuse holder C	5 A	- G397 - Rain and light detector sensor	30
3	- SC3 - Fuse 3 on fuse holder C	20 A	- J364 - Auxiliary heater control unit	30
4	- SC4 - Fuse 4 on fuse holder C	5 A	- R64 - Remote control receiver for auxiliary heating	30
5	- SC5-Fuse 5 on fuse holder C	30 A	- J39 - Headlight washer system relay	30
6	- SC6 - Fuse 6 on fuse holder C	25 A	- J608 - Special vehicle control unit	30
7	- SC7 - Fuse 7 on fuse holder C	5 A	- J794 - Control unit for information electronics 1 R126 - Telephone bracket	30
8	- SC8 - Fuse 8 on fuse holder C	25 A	- J4 - Dual tone horn relay H2 - Treble tone horn H7 - Bass tone horn	30
9	- SC9 - Fuse 9 on fuse holder C	15 A	- J476 - Personal danger alarm control unit	30
10	- SC10 - Fuse 10 on fuse holder C	15 A	- T4ag - Connector for optional equipment	30
11	- Vacant			
12	- Vacant			

Audi A6

Fitting Locations

No. 802 / 52

Location of fuses (SF) on right in luggage compartment

Fuse colours

40 A - orange

30 A - green

25 A - white

20 A - yellow

15 A - blue

10 A - red

7.5 A - brown

5 A - beige

3 A - purple

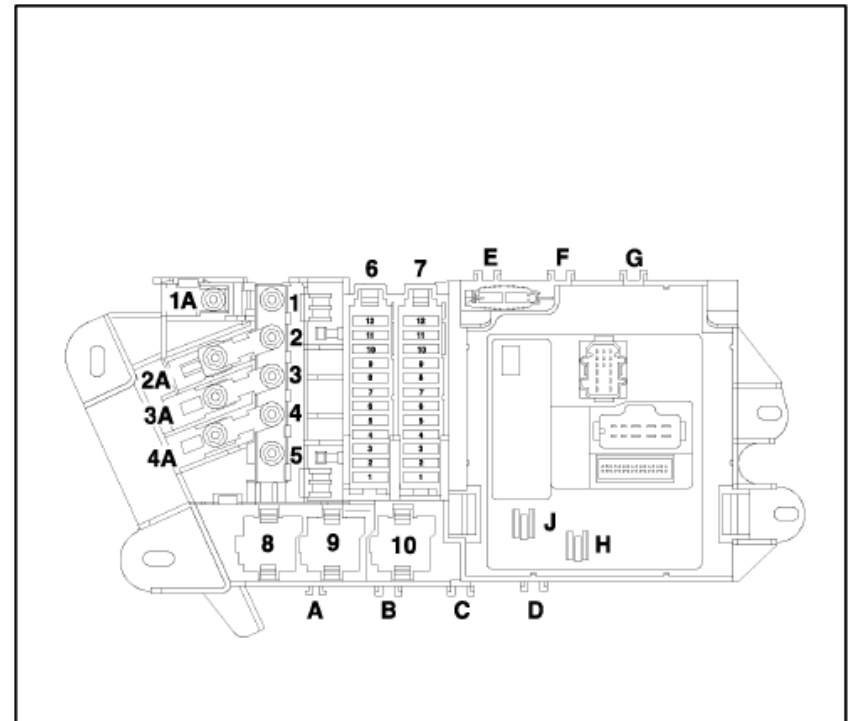
6 - Fuse carrier ST1 (black)**7 - Fuse carrier ST2 (brown)**

Audi A6

Fitting Locations

No. 802 / 53

Position of fuses, fuse holder, from model year 2005

No.	Current Flow Diagram designation Fuse carrier ST1 (black)	Nominal value	Function/component	Terminal
1	- SF1 - Fuse 1 on fuse holder	20A	- J749 - Fuel pump relay for auxiliary heater	30
2	- Vacant			
3	- SF3 - Fuse 3 on fuse holder	30A	- J540 - Electric park and handbrake control unit	30
4	- SF4 - Fuse 4 on fuse holder	30A	- J540 - Electric park and handbrake control unit	30
5	- SF5 - Fuse 5 on fuse holder	20A	- U18 - 12 V socket 2	30
6	- SF6 - Fuse 6 on fuse holder	5A	- J644 - Energy management control unit	30
7	- SF7 - Fuse 7 on fuse holder	20A	- J393 - Convenience system central control unit	30
8	- SF8 - Fuse 8 on fuse holder	5A	- J529 - Anti-theft and tilt system control unit	30
9	- SF9 - Fuse 9 on fuse holder	30A	- J393 - Convenience system central control unit	30
10	- SF10 - Fuse 10 on fuse holder	35A	- V27 - Rear right window regulator motor ¹⁾ V148 - Front passenger side window regulator motor ¹⁾ -	30
11	- SF11 - Fuse 11 on fuse holder	10A 20A	- J446 - Parking aid control unit U1 - Cigarette lighter (right-hand drive)	30
12	- SF12 - Fuse 12 on fuse holder	20A	- U9 - Rear cigarette lighter	30

1) from November 2005

Audi A6

Fitting Locations

No. 802 / 54

No.	Current Flow Diagram designation Fuse carrier ST2 (brown)	Nominal value	Function/component	Terminal
1	- Vacant			
2	- SF2 - Fuse 2 on fuse holder	30A	- J605 - Rear lid control unit	30
3	- SF3 - Fuse 3 on fuse holder	30A	- J756 - Rear lid control unit 2	30
4	- SF4 - Fuse 4 on fuse holder	20A	- J657 - Power latching control unit	30
5	- SF5 - Fuse 5 on fuse holder	5A	- R - Radio	30
6	- SF6 - Fuse 6 on fuse holder	5A	- R78 - TV tuner	30
7	- SF7 - Fuse 7 on fuse holder	5A	- J401 - Navigation system with CD drive control unit	30
8	- SF8 - Fuse 8 on fuse holder	30A	- J525 - Digital sound package control unit	30
9	- SF9 - Fuse 9 on fuse holder	5A	- R147 Digital radio -	30
10	- SF10 - Fuse 10 on fuse holder	15A	- J345 - Trailer detector control unit	30
11	- SF11 - Fuse 11 on fuse holder	15A	- J345 - Trailer detector control unit	30
12	- SF12 - Fuse 12 on fuse holder	15A	- J345 - Trailer detector control unit	30

Audi A6

Fitting Locations

No. 802 / 55

Position of fuses, fuse holder, from model year 2007

No.	Current Flow Diagram designation Fuse carrier ST1 (black)	Nominal value	Function/component	Terminal
1	- SF1 - Fuse 1 on fuse holder F	30 A	- J525 - Digital sound package control unit	30
2	- SF2 - Fuse 2 on fuse holder F	5 A	- R - Radio R24 - Aerial amplifier	30
3	- SF3 - Fuse 3 on fuse holder F	30 A	- J540 - Electric park and handbrake control unit	30
4	- SF4 - Fuse 4 on fuse holder F	30 A	- J540 - Electric park and handbrake control unit	30
5	- SF5 - Fuse 5 on fuse holder F	20 A	- U18 - 12 V socket -2-	30
6	- SF6 - Fuse 6 on fuse holder F	5 A	- J644 - Energy management control unit	30
7	- SF7 - Fuse 7 on fuse holder F	20 A	- J393 - Convenience system central control unit	30
8	- SF8 - Fuse 8 on fuse holder F	5 A	- J401 - Navigation system with CD drive control unit	30
9	- SF9 - Fuse 9 on fuse holder F	30 A	- J393 - Convenience system central control unit	30
10	- SF10 - Fuse 10 on fuse holder F	35 A	- V27 - Rear right window regulator motor V148 - Front passenger side window regulator motor	30
11	- SF11 - Fuse 11 on fuse holder F	10 A 5 A ¹⁾ 20 A	- J446 - Parking aid control unit U1 - Cigarette lighter (right-hand drive only)	30
12	- SF12 - Fuse 12 on fuse holder F	20 A	- U9 - Rear cigarette lighter	30

1) from June 2007

Audi A6

Fitting Locations

No. 802 / 56

No.	Current Flow Diagram designation Fuse carrier ST2 (brown)	Nominal value	Function/component	Terminal
1	- SF1 - Fuse 1 on fuse holder F	5 A	- J772 - Reversing camera system control unit	30
2	- SF2 - Fuse 2 on fuse holder F	30 A	- J605 - Rear lid control unit	30
3	- SF3 - Fuse 3 on fuse holder F	30 A	- J756 - Rear lid control unit 2	30
4	- SF4 - Fuse 4 on fuse holder F	20 A	- J657 - Power latching control unit	30
5	- Vacant			
6	- SF6 - Fuse 6 on fuse holder F	5 A	- R78 - TV tuner	30
7	- SF7 - Fuse 7 on fuse holder F	5 A	- J393 - Convenience system central control unit	30
8	- SF8 - Fuse 8 on fuse holder F	20 A	- J749 - Fuel pump relay for auxiliary heater	30
9	- SF9 - Fuse 9 on fuse holder F	5 A	- R147 - Digital radio	30
10	- SF10 - Fuse 10 on fuse holder F	15 A	- J345 - Trailer detector control unit	30
11	- SF11 - Fuse 11 on fuse holder F	15 A	- J345 - Trailer detector control unit	30
12	- SF12 - Fuse 12 on fuse holder F	15 A	- J345 - Trailer detector control unit	30

Audi A6

Fitting Locations

No. 802 / 57

Position of fuses, fuse holder, from model year 2009

No.	Current Flow Diagram designation Fuse carrier ST1 (black)	Nominal value	Function/component	Terminal
1	- SF1 - Fuse 1 on fuse holder F	30 A	- J525 - Digital sound package control unit R - Radio ²⁾	30
2	- SF2 - Fuse 2 on fuse holder F	5 A	- R - Radio ¹⁾	30
3	- SF3 - Fuse 3 on fuse holder F	30 A	- J540 - Electric park and handbrake control unit	30
4	- SF4 - Fuse 4 on fuse holder F	30 A	- J540 - Electric park and handbrake control unit	30
5	- SF5 - Fuse 5 on fuse holder F	20 A	- U18 - 12 V socket -2-	30
6	- SF6 - Fuse 6 on fuse holder F	5 A	- J644 - Energy management control unit	30
7	- SF7 - Fuse 7 on fuse holder F	20 A	- J393 - Convenience system central control unit	30
8	- SF8 - Fuse 8 on fuse holder F	5 A	- G273 - Interior monitoring sensor H12 - Alarm horn	30
9	- SF9 - Fuse 9 on fuse holder F	30 A	- J393 - Convenience system central control unit	30
10	- SF10 - Fuse 10 on fuse holder F	35 A	- V27 - Rear right window regulator motor V148 - Front passenger side window regulator motor	30
11	- SF11 - Fuse 11 on fuse holder F	5 A 20 A	- J446 - Parking aid control unit U1 - Cigarette lighter (right-hand drive only)	30
12	- SF12 - Fuse 12 on fuse holder F	20 A	- U9 - Rear cigarette lighter	30

1) models with BOSE soundsystem

2) models with soundsystem standard

Audi A6

Fitting Locations

No. 802 / 58

No.	Current Flow Diagram designation Fuse carrier ST2 (brown)	Nominal value	Function/component	Terminal
1	- SF1 - Fuse 1 on fuse holder F	5 A	- J772 - Reversing camera system control unit	30
2	- SF2 - Fuse 2 on fuse holder F	30 A	- J605 - Rear lid control unit	30
3	- SF3 - Fuse 3 on fuse holder F	30 A	- J756 - Rear lid control unit 2	30
4	- SF4 - Fuse 4 on fuse holder F	20 A	- J657 - Power latching control unit	30
5	- SF5 - Fuse 5 on fuse holder F	5 A	- Interface for special functions:	30
6	- SF6 - Fuse 6 on fuse holder F	5 A	- R78 - TV tuner	30
7	- SF7 - Fuse 7 on fuse holder F	5 A	- J393 - Convenience system central control unit	30
8	- SF8 - Fuse 8 on fuse holder F	20 A	- J749 - Fuel pump relay for auxiliary heater	30
9	- Vacant			
10	- SF10 - Fuse 10 on fuse holder F	15 A	- J345 - Trailer detector control unit	30
11	- SF11 - Fuse 11 on fuse holder F	20 A	- J345 - Trailer detector control unit	30
12	- SF12 - Fuse 12 on fuse holder F	20 A	- J345 - Trailer detector control unit	30

Audi A6

Fitting Locations

No. 802 / 59

Fuses behind driver's storage compartment

Position of fuses, fuse holder, from model year 2005

A - ABS control unit fuse 1 - S123 (40A)

B - Vacant

C - Vacant

D - Vacant

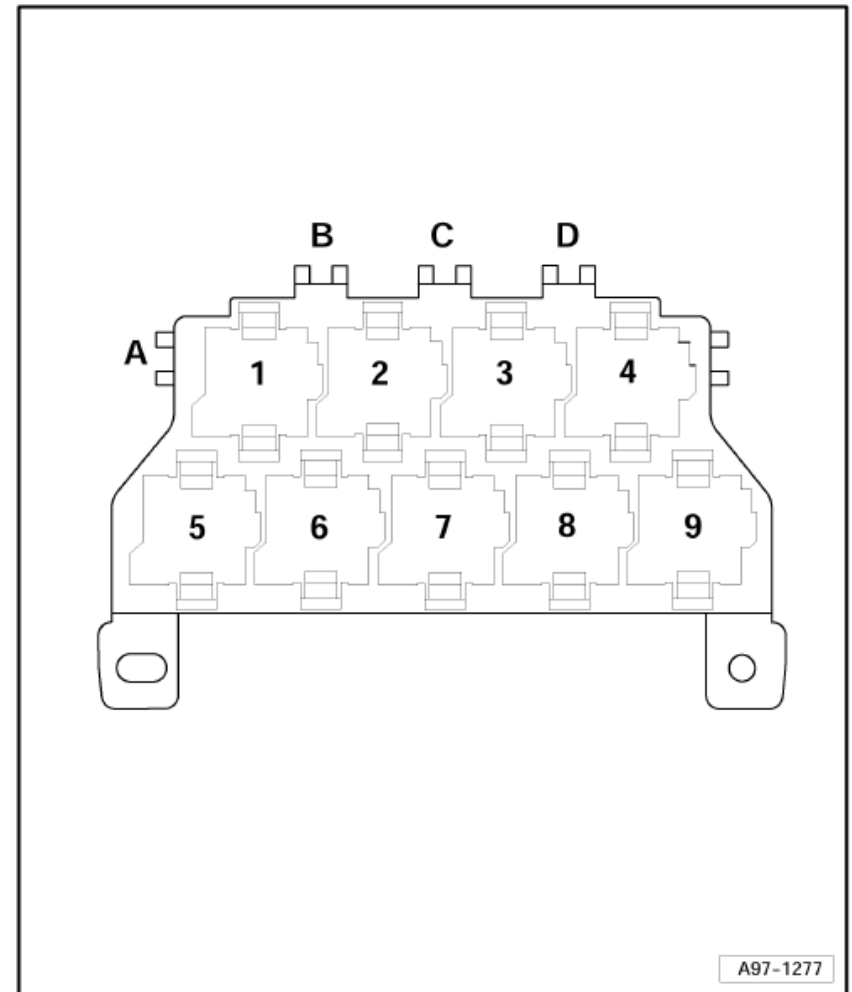

Audi A6

Fitting Locations

No. 802 / 60

Position of fuses, fuse holder, left-hand drive, from model year 2007

- A - ABS control unit fuse 1 -S123- (40 A)
- B - Vacant
- C - Driver seat adjustment thermal fuse 1 -S44- (30 A)
- D - Vacant (up to August 2008)
 - Communications fuse -S254- (5 A) (from September 2008)
- E - Vacant

Position of fuses, fuse holder, right-hand drive, from model year 2007

- A - Vacant
- B - Vacant (up to August 2008)
 - Communications fuse -S254- (5 A) (from September 2008)
- C - Driver seat adjustment thermal fuse 1 -S44- (30 A)
- D - Vacant
- E - ABS control unit fuse 1 -S123- (40 A)

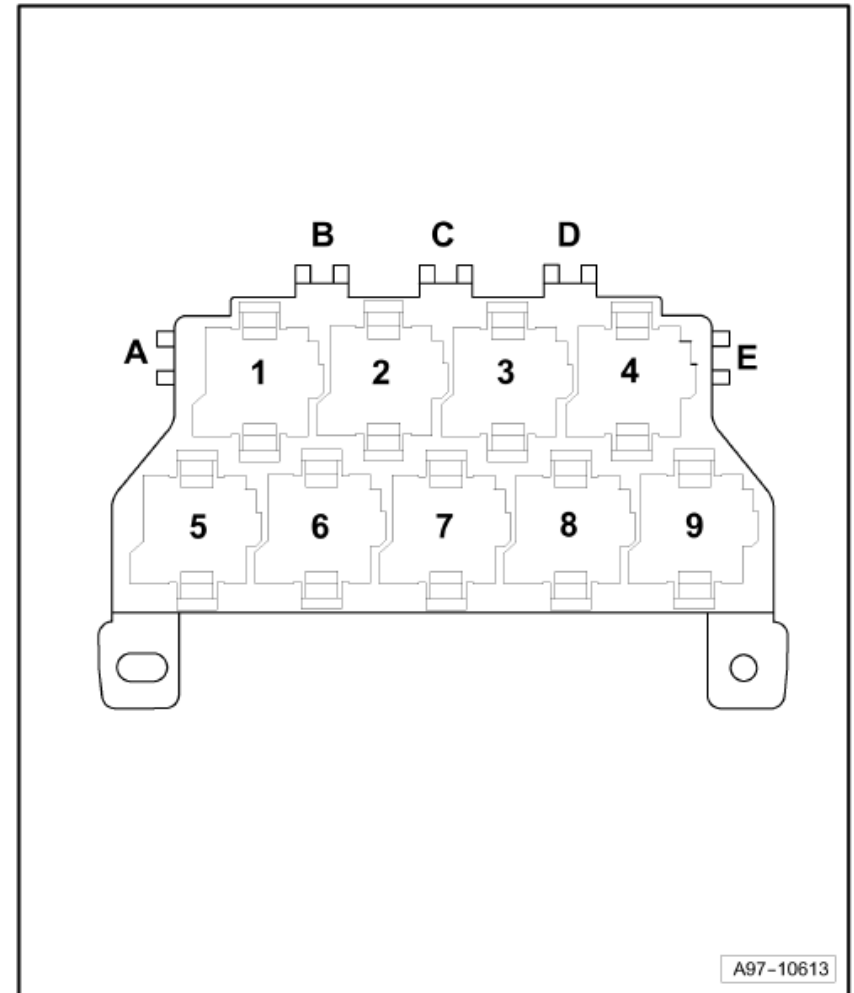

Audi A6

Fitting Locations

No. 802 / 61

Fuses on onboard supply control unit -J519-

Position of fuses, fuse holder

- 1 - Vacant
- 2 - Window regulator single fuse 2 -S280- (30A)
 - up to October 2005
- 2 - Heater element fuse 1 -S276- (40 A)
 - from June 2007
- 3 - Driver seat adjustment thermal fuse 1 -S44- (30A), driver seat adjustment fuse 1 -S44- (only lumbar support 10A)
 - is dropped, from model year 2007
 - for models from model year 2007 → [page 802/60](#)
- 4 - Window regulator single fuse -S37- (30A)
 - up to October 2005
- 5 - Heater element fuse 2 -S277- (50 A)
 - from June 2007

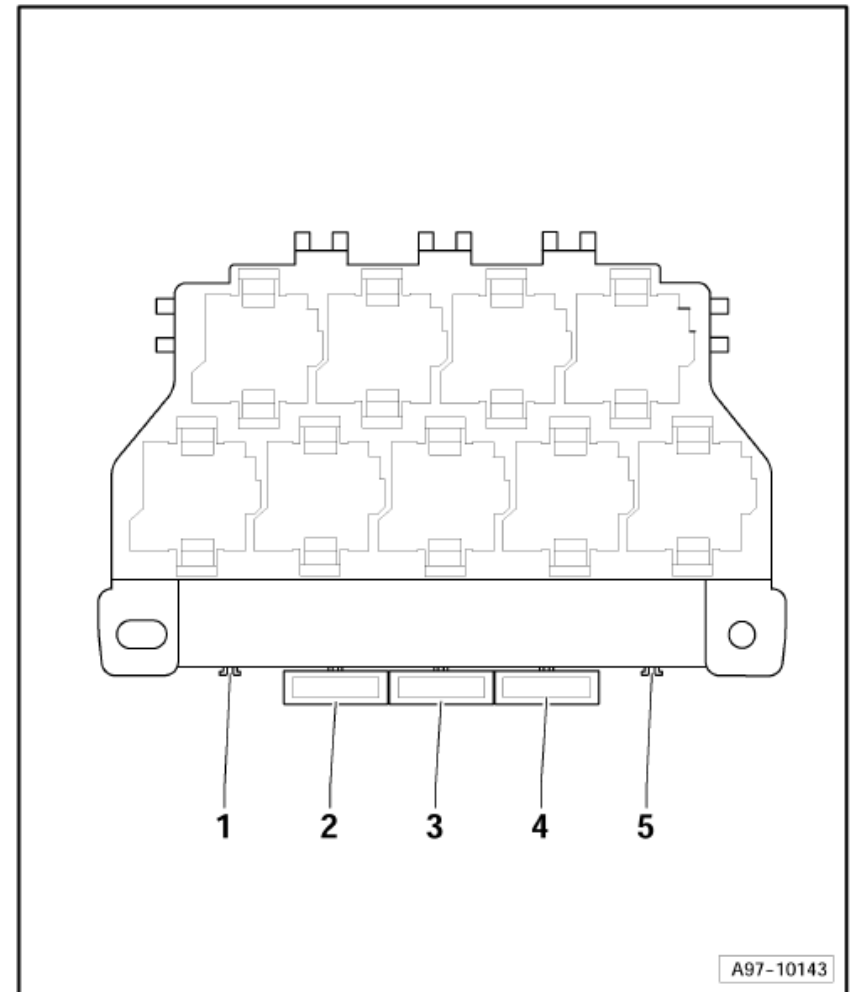

Audi A6

Fitting Locations

No. 802 / 62

Fuses in electronics box, right in plenum chamber

Position of fuses, fuse holder, from model year 2005

- A - Vacant
- B - Glow plug fuse -S125- (80A), secondary air pump fuse -S130- (50A)
- C - Levelling system fuse -S110- (40A)
- D - Glow plug fuse 2 -S189- (80A), radiator fan fuse for 3rd speed -S94- (15A) (BGS)
- E - Vacant
- F - Vacant
- G - Vacant

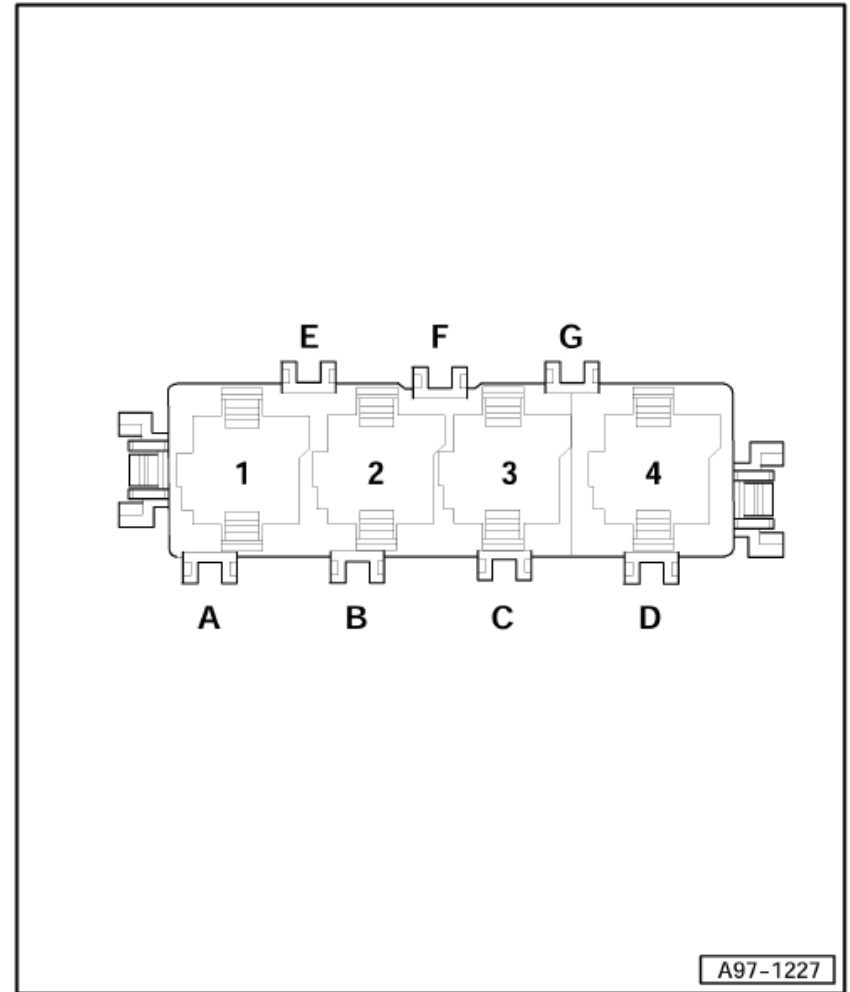

Audi A6

Fitting Locations

No. 802 / 63

Position of fuses, fuse holder, left-hand drive, from model year 2007

- A - Vacant
- B - Glow plug fuse -S125- (80 A), secondary air pump fuse -S130- (50 A)
- C - Levelling system fuse -S110- (40 A)
- C - Radiator fan fuse for 3rd speed -S94- (30A) (5.0 I-engine BUH)
- D - Glow plug fuse 2 -S189- (80 A)
- E - Vacant
- F - Vacant
- G - Vacant

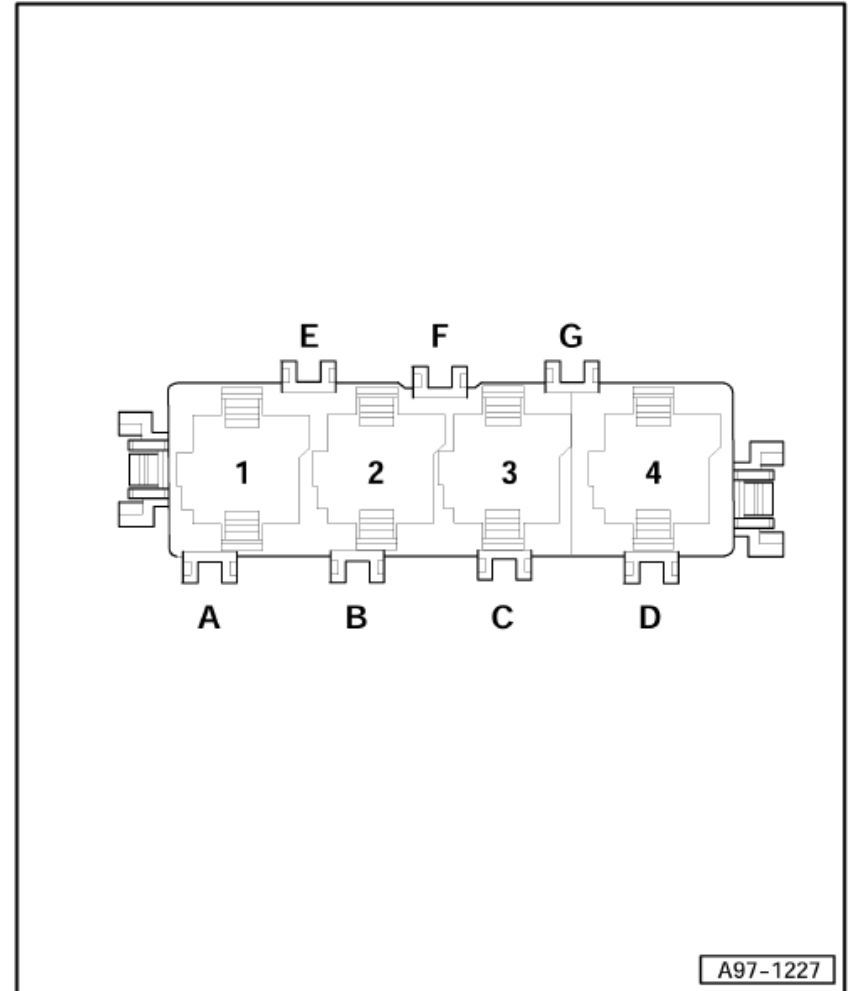

Audi A6

Fitting Locations

No. 802 / 64

Position of fuses, fuse holder, right-hand drive, from model year 2007

A - Vacant

B - Glow plug fuse -S125- (80 A), secondary air pump fuse -S130- (50 A)

C - Levelling system fuse -S110- (40 A), radiator fan fuse for 3rd speed -S94- (30 A)

D - Glow plug fuse 2 -S189- (80 A)

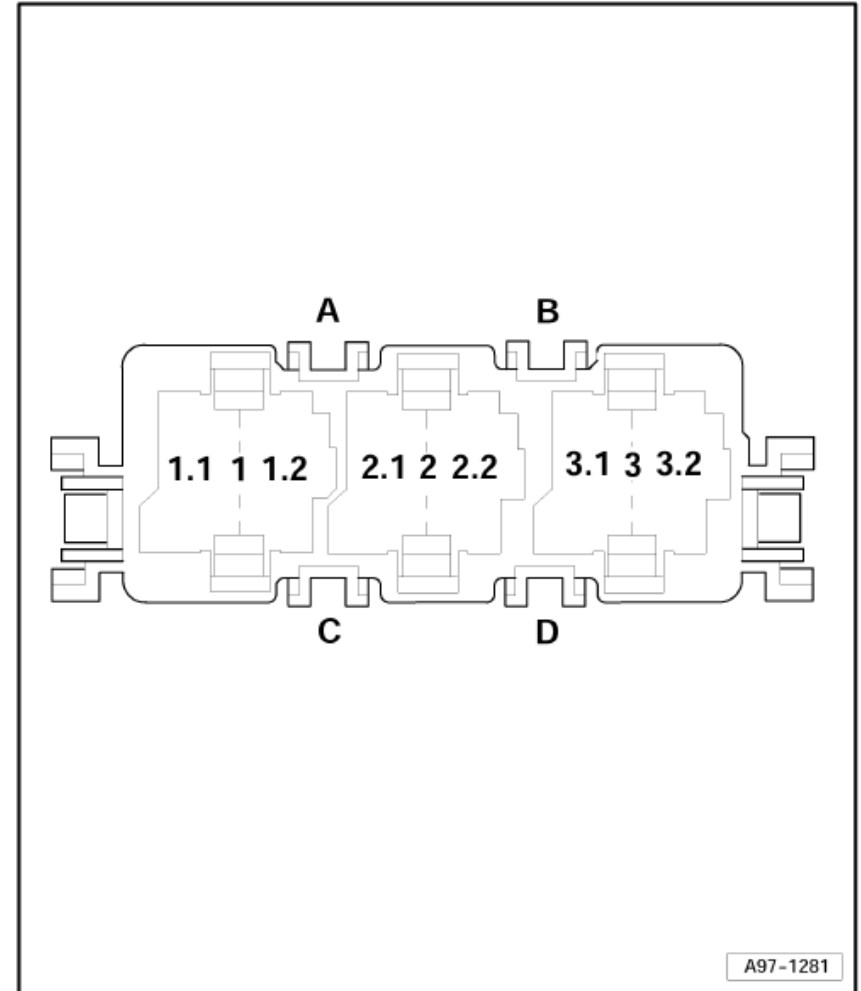

Audi A6

Fitting Locations

No. 802 / 65

Fuses in electronics box, left in plenum chamber

Position of fuses, fuse holder, left-hand drive, from model year 2007

- A - Vacant
- B - Vacant
- C - Vacant
- D - Vacant

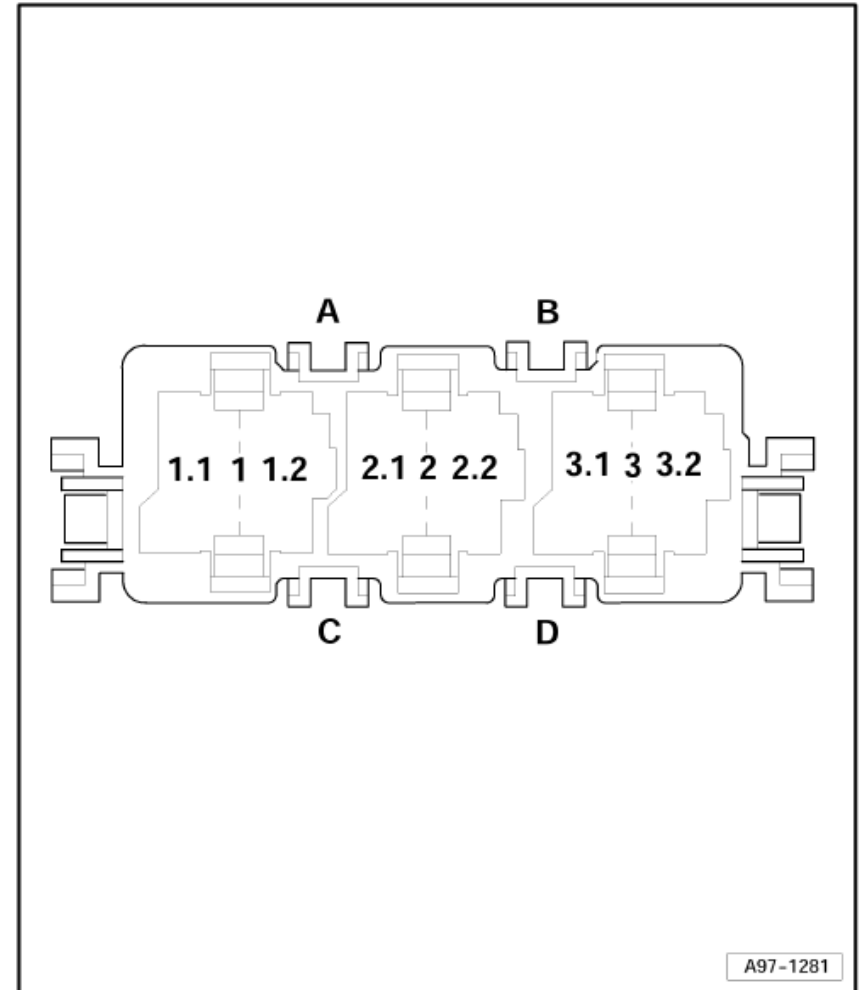

Audi A6**Fitting Locations****No. 802 / 66****Position of fuses, fuse holder, right-hand drive, from model year 2007**

- A - Vacant
- B - Vacant
- C - Vacant
- D - Vacant
- E - Vacant
- F - Vacant
- G - Vacant

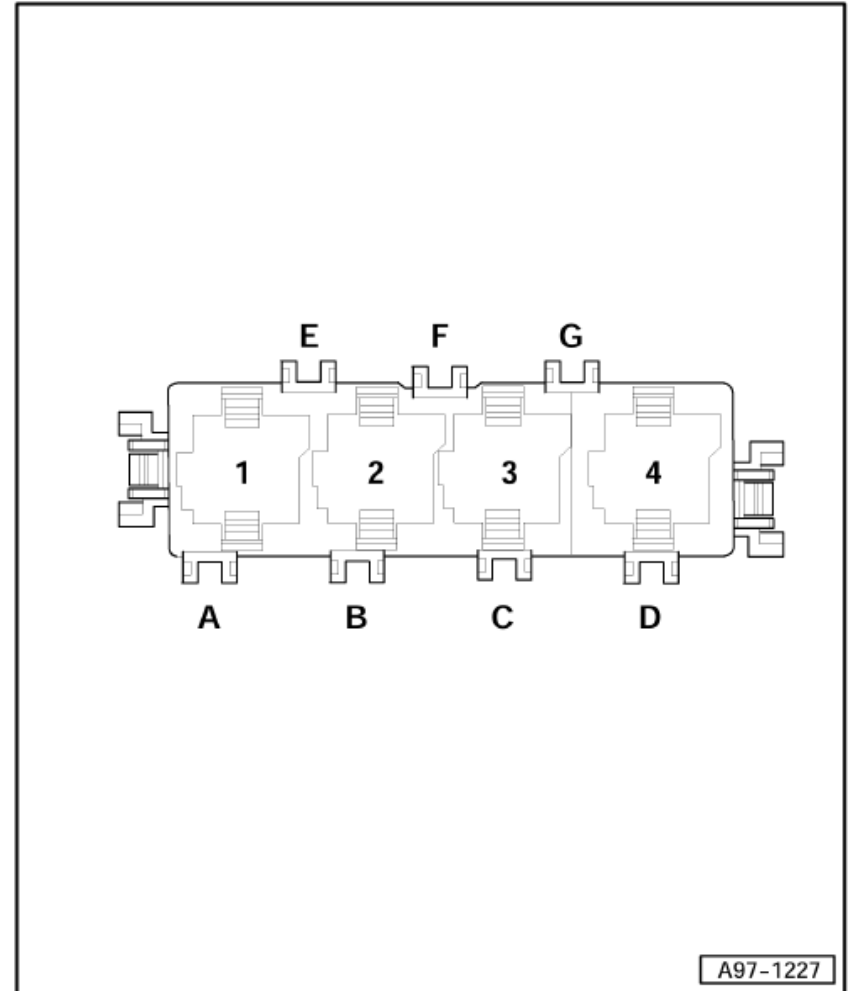

Audi A6

Fitting Locations

No. 802 / 67

Fuses, on right in luggage compartment

Position of fuses, fuse holder, from model year 2005

- 1 - Connection for wire to fuse carrier ST1 and ST2
- 1A - Fuse -S131- vacant
- 2A - Fuse -S132- (Strip fuse 150A)
- 3A - Fuse -S133- (strip fuse 80A, only council vehicles), fuse -S133- (strip fuse 40A, only driving school vehicles and taxi)
- 4A - Fuse -S134- vacant
- 5 - Connection for wire from battery +
- 6 - Fuse carrier ST1 (black)
- 7 - Fuse carrier ST2 (brown)

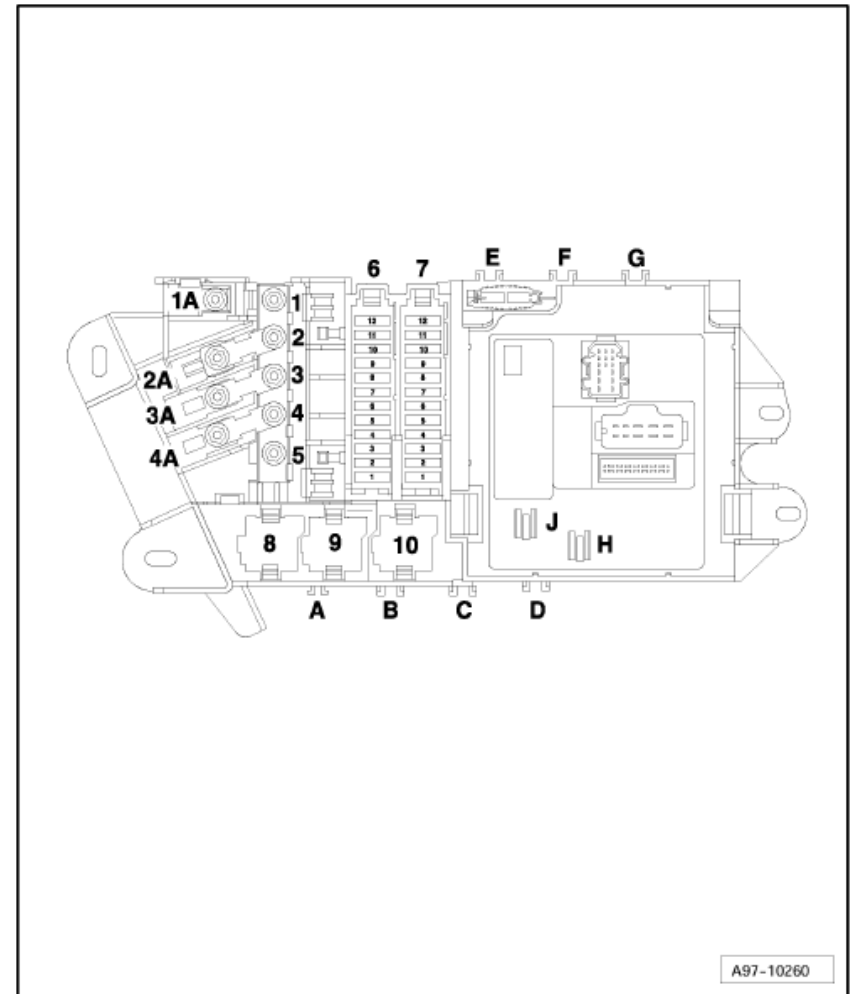

Audi A6

Fitting Locations

No. 802 / 68

- B - Vacant
- C - Heated rear window single fuse - S41 (40A) (up to October 2005)
- D - Vacant
- E - Vacant
- F - Vacant
- G - Vacant
- H - Heated rear window single fuse - S41 (40A) (from November 2005)
- J - Vacant

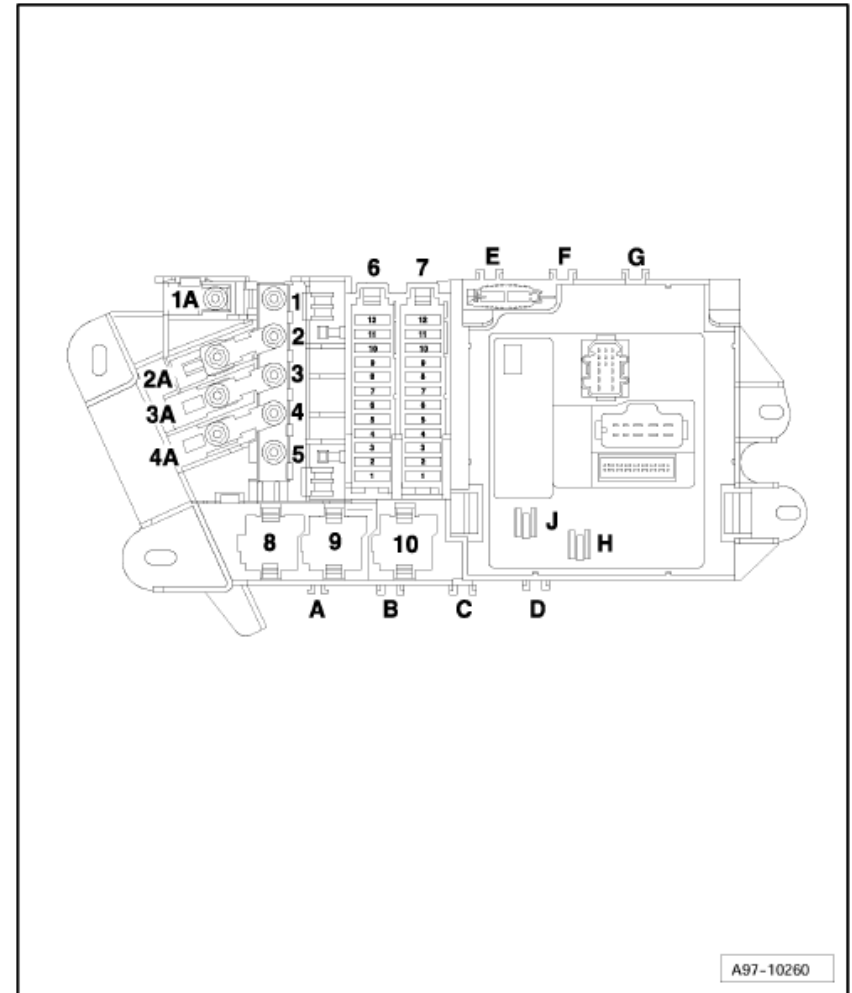

Audi A6

Fitting Locations

No. 802 / 69

Position of fuses, fuse holder, from model year 2007

- 4 - Fuse carrier ST1 (black)
- 5 - Fuse carrier ST2 (brown)
- A - Vacant
- B - Personal danger alarm control unit -J476- (15 A) right-hand drive only
- C - Vacant
- D - Signal system operating unit control unit -J615- (25 A) right-hand drive only
- E - Vacant
- F - Vacant
- G - Vacant
- H - Heated rear window fuse -S41- (40 A)
- J - Vacant

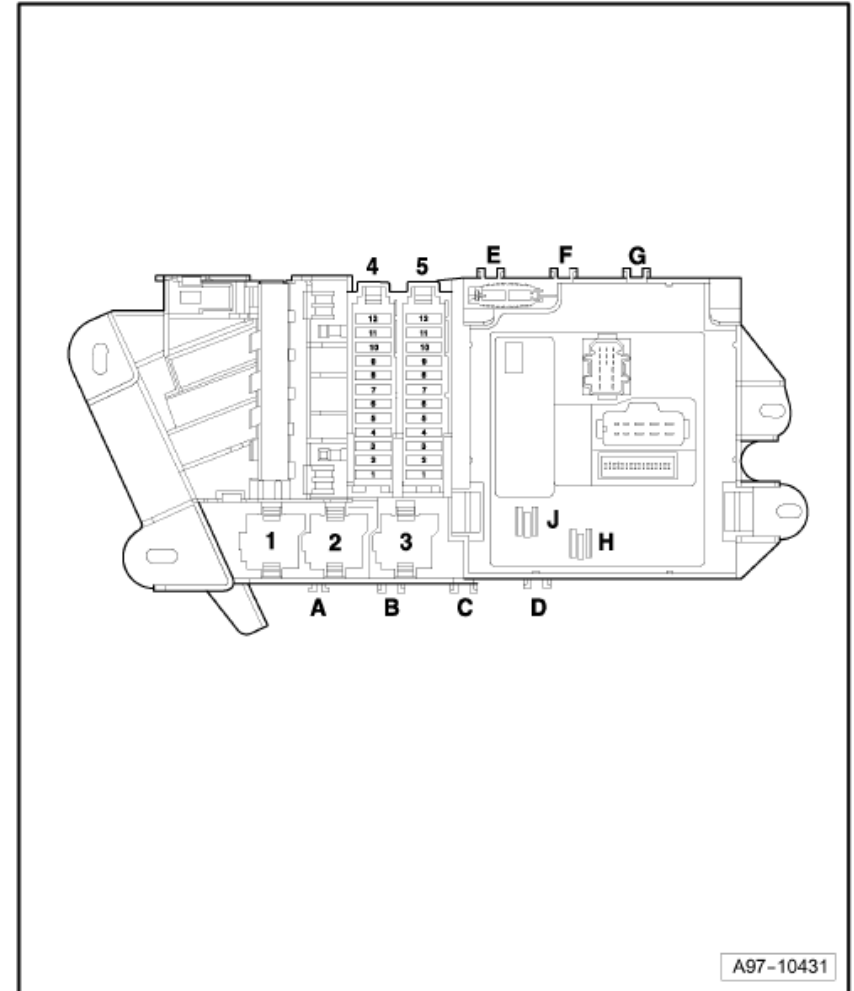

Audi A6

Fitting Locations

No. 802 / 70

Fuses on steering cross member

Position of fuses, fuse holder

A - Heater element fuse 1 -S276- (1nd speed), (40A)

- up to May 2007
- for models from June 2007 → [page 802/61](#)

B - Heater element fuse 2 -S277- (2+3nd speed), (60A)

- up to May 2007
- for models from June 2007 → [page 802/61](#)

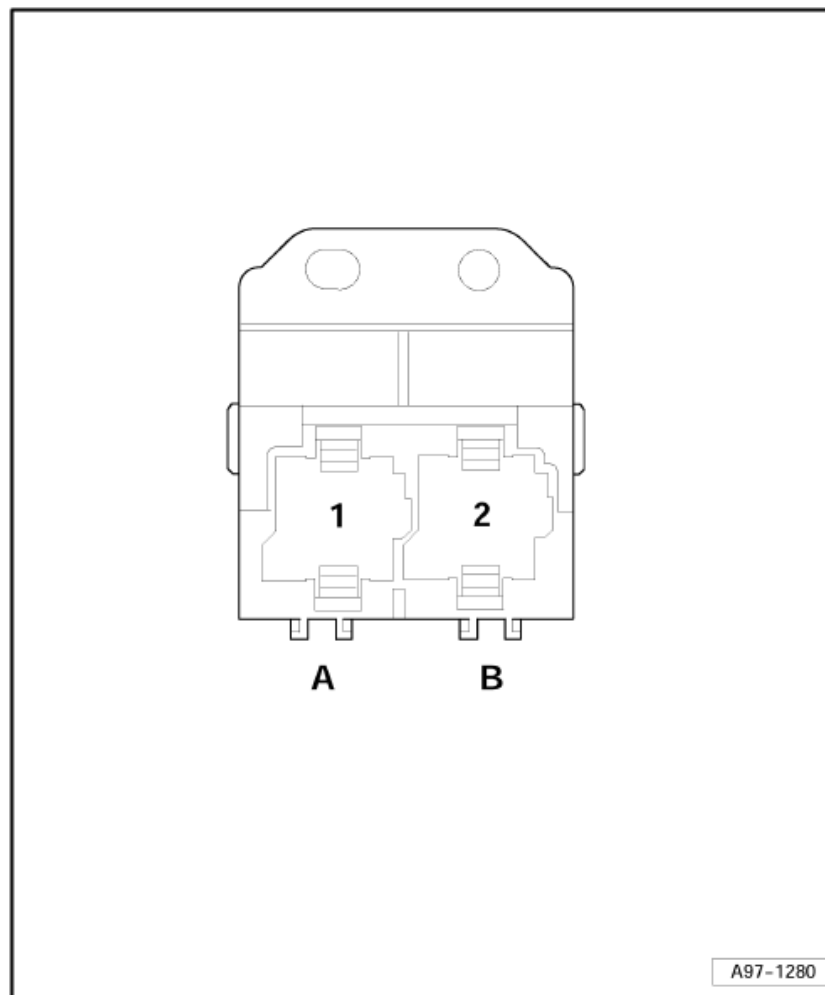

Audi A6

Fitting Locations

No. 802 / 71

Fuses on main fuse carrier electronics box, right in plenum chamber

Position of fuses, fuse holder

- 1 - Union (terminal 30)
- 2 - Radiator fan fuse for 2nd speed -S104- (40A/ 60A)
- 3 - Radiator fan single fuse -S42- (40A/ 60A)
- 4 - Battery positive cable union
- 5 - Vacant
- A - Vacant
- B - Vacant

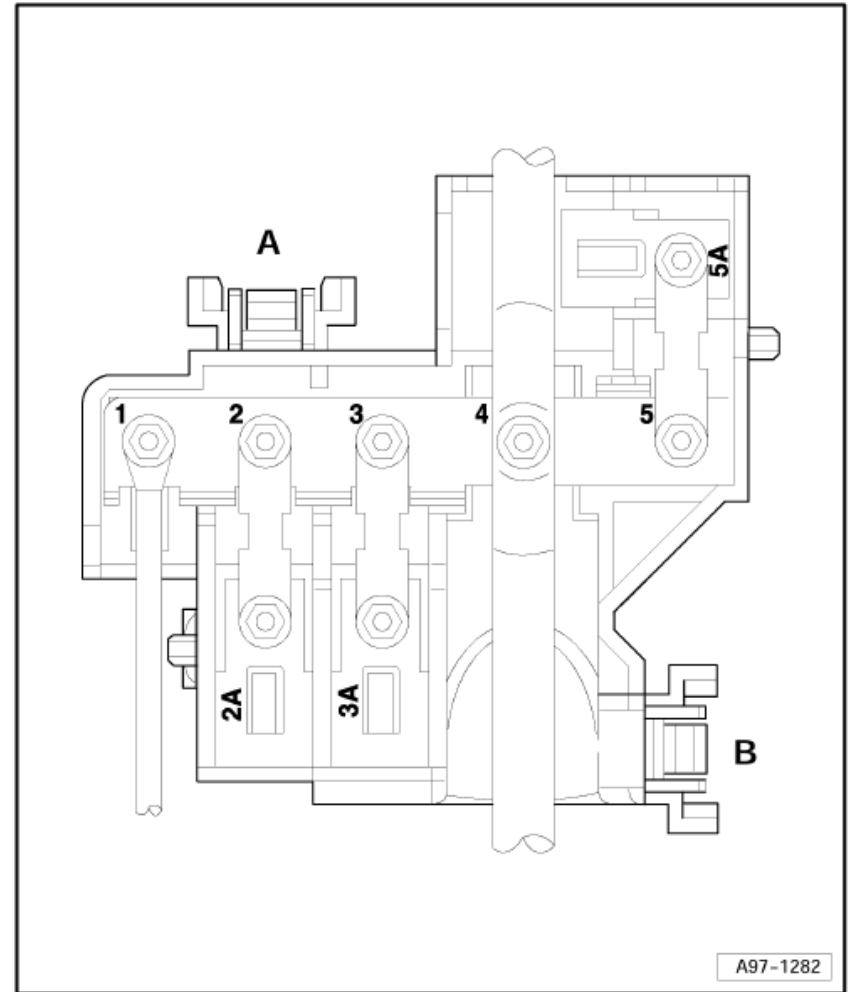

Audi A6

Fitting Locations

No. 802 / 72

Fuses in luggage compartment, rear right, on the battery

Position of fuses, fuse holder, from model year 2007

- A1 - Connection battery positive
- B1 - Connection to energy management control unit -J644-
- C1 - Strip fuse 40 A, only driving school vehicles and taxi
 - Strip fuse 80 A, only council vehicles
 - Strip fuse 30 A, RS6 engine BUH only
- D1 - Strip fuse 110 A, supply fuse carrier right in luggage compartment
- E1 - Strip fuse 110 A, supply onboard supply control unit, ABS control unit -J104-
- F1 - Connection to starter -B-

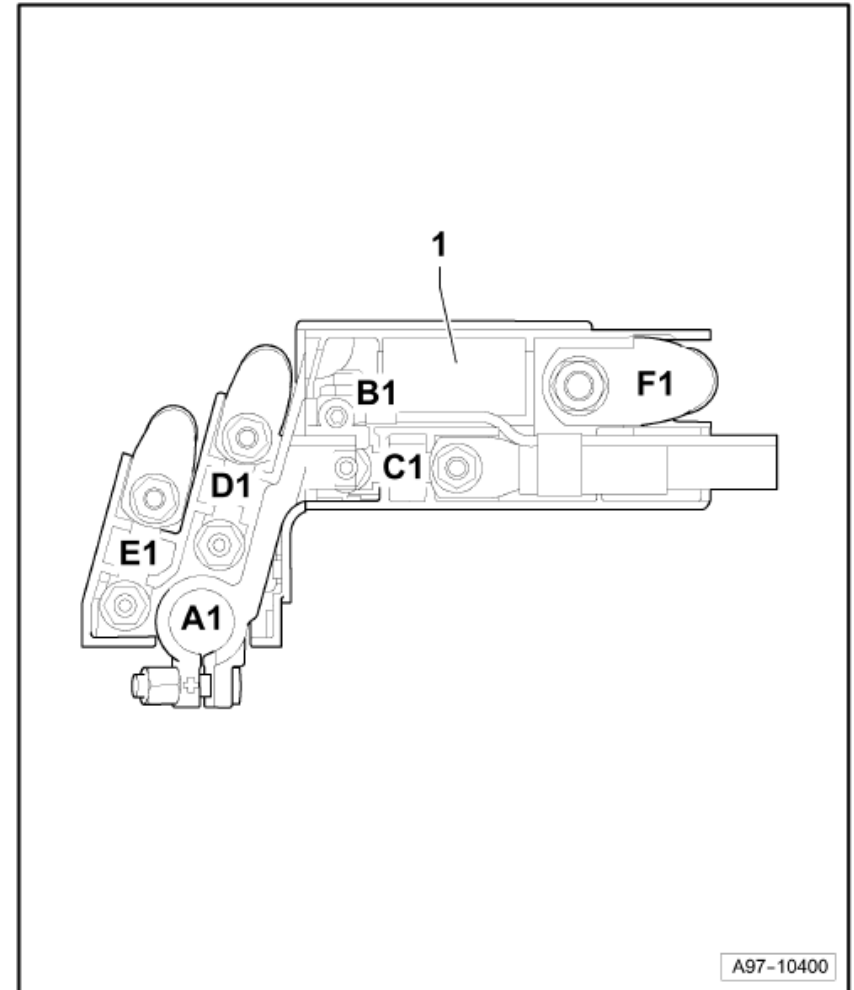

Audi A6

Fitting Locations

No. 802 / 73

Fuses on coupling station, lower part of right A-pillar

Position of fuses, fuse holder

- 15 - Front passenger seat adjustment thermal fuse 1 -S46- (30A) (is dropped, from model year 2007)
- 15 - Front passenger seat adjustment fuse 1 -S46- (10A) (only lumbar support) (is dropped, from model year 2007)

